



## Engineering Recommendation G98

Issue 1 Amendment 6 September 2021

Requirements for the connection of Fully Type Tested Micro-generators (up to and including 16 A per phase) in parallel with public Low Voltage Distribution Networks on or after 27 April 2019

PUBLISHING AND COPYRIGHT INFORMATION

© 2021 Energy Networks Association

All rights reserved. No part of this publication may be reproduced, stored in a retrieval system or transmitted in any form or by any means, electronic, mechanical, photocopying, recording or otherwise, without the prior written consent of Energy Networks Association. Specific enquiries concerning this document should be addressed to:

**Operations Directorate  
Energy Networks Association  
4 More London Riverside  
London  
SE1 2AU**

This document has been prepared for use by members of the Energy Networks Association to take account of the conditions which apply to them. Advice should be taken from an appropriately qualified engineer on the suitability of this document for any other purpose.

First published, May, 2018

**Amendments since publication**

Issue	Date	Amendment
G98/1-1	23 July 2018	House keeping modification <ol style="list-style-type: none"> <li>1. To implement the Authority's decision on DC0079, ie to disallow the use of VS protection and to provide new RoCoF requirements for type tested generation. Changes to clauses 9.2.1; 10.1.3; 10.3.3; 10.3.4; Form C; A.1.2.6; A.2.2.6.</li> <li>2. Correction of implementation date to 27 April 2019 throughout.</li> <li>3. A small number of minor typographical corrections throughout</li> </ol>
G98/1-2	10 Dec 2018	Modification to incorporate Integrated Micro Generation and Storage procedure (otherwise known as the energy storage fast track procedure) into EREC G98 and G99.  A small number of minor typographical corrections throughout.
G98/1-3	14 March 2019	Amendments to add new fuel/technology type to Appendix 3
G98/1-4	16 June 2019	Modification to remove Type Tested definition and ensure all references are to Fully Type Tested as applicable to this EREC G98.  Alignment of protection type testing compliance values in Form C with those used in EREC G99.  Paragraph 7.6, voltage management units included.  Multiple premises connection procedure: Paragraphs 5.2.2 and 5.3.1 moved from Section 8.  Modification to Installation Form B in respect of logging Micro-generator data when there are several Micro-generators in one installation.

		<p>Modification to add clarity to introduction in Form C.</p> <p>Clarification in Annexes A1 and A2 in respect of applicability in respect of energy storage systems and load management devices</p>
G98/1-5	01 August 2021	<p>Modification to Remove Electricity Storage from exceptions (2.15 and Appendix 1) after an implementation date and amending the foreword and footnote (1).</p> <p>New Section 9.4.3 on falling frequency.</p> <p>Inclusion of storage frequency tests A.1.2.8 and A.2.2.8.</p> <p>Inclusion of reference to vehicle to grid in foreword and Electricity Storage definition.</p>
G98/1-6	01 Sept 2021	<p>Minor technical modifications:</p> <ol style="list-style-type: none"> <li>1. Removal of sentence in Foreword that is out of date.</li> <li>2. Removal of reference to EN 50438, which has been withdrawn, and re-instatement of relevant clauses. Includes modifications to Foreword; 1.4; 2.1; 2.8 (clause removed); 2.12; 3.2; 6.2.2; 7.2.1 (including new Figure 1); 7.3.1; 7.7; 9.3; 9.5; 9.6; 10.1.10; 10.2; 11.1; 11.2; 11.3; 11.4; Form C Type Test Verification Report; Annex A1 (A1.1, A.1.2.2, A.1.2.3, A.1.2.7, A.1.2.9, A.1.2.10, A.1.3.2, A.1.3.4, removal of A.1.3.7); and Annex A2 (A.2.2.4, A.2.3.2, A.2.3.4, removal of A.2.3.5).</li> <li>3. Clarification in 2.8 that the threshold is less than or equal to 16 A per phase.</li> <li>4. Amended product ID to system reference in 2.13 and in forms, as per updates to ENA Type Test register.</li> <li>5. Updates to the titles of EREC G5 and EREC P28 in the references.</li> <li>6. New references to cyber security guidance documents, a requirement to comply with these in a new clause 9.7 and additional check on compliance in Form C: Type Test Verification Report.</li> <li>7. Modification to the definition of Registered Capacity to align with the latest version of EREC G99 and to include footnote.</li> <li>8. Allowing for a family approach to type testing in new clauses from 6.3.</li> <li>9. Removal of FIT meter in Figure 2 Example of circuit diagram and combined import / export meter in Meter Operator's installation.</li> <li>10. New clause 8.4.4 on substantial modifications to EREC G83 installations, including new footnote.</li> <li>11. New clauses 9.3.3 and 9.3.4 on minimum stable operating level during LFSM-O.</li> <li>12. Addition of field for energy storage capacity (kWh) for energy storage devices in Form A and Form B.</li> <li>13. Updates to the energy source / energy conversion technologies table at the end of Form B Installation document, Appendix 3.</li> <li>14. Modifications to recognise the limitations of small rotating machines to operate stably at low output, including changes to Form C: Type Test Verification Report (new footnotes 7 and 8) and additional guidance in A.2.2.4 and A.2.3.1.</li> <li>15. Modifications for Form C: Type Test Verification Report including:</li> </ol>

## PUBLISHING AND COPYRIGHT INFORMATION

		<ul style="list-style-type: none"><li>a. Additional guidance;</li><li>b. New operating range tests (Test 1 47.0 Hz, Test 5 continuous operation and Test 6 RoCoF withstand);</li><li>c. A field in the harmonics test sheet to indicate, for 3-phase Micro-generators, whether measurements for all phases are the same;</li><li>d. Moved fields for test dates and location to top of voltage fluctuations and flicker test sheet;</li><li>e. Removed four rows in the Power Factor test sheet for results at different levels of Registered Capacity and replaced with a single row for measured output (aligned with equivalent G99 forms); and</li><li>f. Added a clear check box for logic interface port and new requirement to provide a high-level description of the logic interface.</li></ul> <p>16. A small number of minor typographical corrections throughout.</p>
--	--	-----------------------------------------------------------------------------------------------------------------------------------------------------------------------------------------------------------------------------------------------------------------------------------------------------------------------------------------------------------------------------------------------------------------------------------------------------------------------------------------------------------------------------------------------------------------------------------------------------------------------------------------------------------------------------------------------------------------------------------------------------------------------------------------------------------------------------------------------------------------------------------

## Contents

Foreword.....	7
1 Legal aspects.....	9
2 Scope .....	10
3 References .....	13
3.1 Regulations and Directives .....	13
3.2 Standards publications.....	14
3.3 Other publications.....	15
4 Terms and definitions.....	16
5 Connection Procedure .....	19
5.1 Single Premises Connection Procedure.....	19
5.2 Multiple Premises Connection Procedure .....	19
5.3 General.....	20
6 Certification Requirements.....	20
6.1 Type Test Certification .....	20
6.2 Compliance.....	21
6.3 Family approach to Type Testing.....	21
7 Operation and Safety .....	22
7.1 Operational Requirements .....	22
7.2 Installation Wiring and Isolation.....	22
7.3 Labelling .....	22
7.4 Maintenance & Routine Testing .....	23
7.5 Phase Unbalance .....	24
7.6 Voltage Management Units.....	24
7.7 Earthing .....	24
8 Commissioning, Notification and Decommissioning .....	24
8.1 General.....	24
8.2 Commissioning .....	25
8.3 Notification of Commissioning.....	25
8.4 Notification of Changes.....	25
8.5 Notification of Decommissioning .....	26
9 General Technical Requirements.....	27
9.1 Frequency withstand.....	27
9.2 Rate of Change of Frequency .....	27
9.3 Limited Frequency Sensitive Mode – Overfrequency .....	27
9.4 Active Power Output .....	28
9.5 Power Factor .....	29
9.6 Automatic Connection.....	29
9.7 Cyber Security .....	29
10 Interface Protection.....	31
10.1 General.....	31
10.2 Loss of Mains Protection.....	32

- 10.3 Frequency Drift and Step Change Stability Test.....33
- 11 Quality of Supply .....34
  - 11.3 Electromagnetic Compatibility (EMC).....34
  - 11.4 Short Circuit Current Contribution .....34
- Appendix 1 Emerging Technologies and other Exceptions.....35
  - Emerging Technologies .....35
- Appendix 2 Connection Procedure Flow Chart .....37
- Appendix 3. Micro-generator Documentation.....38
- Appendix 4 Relaxation of Commissioning Notification Timescales for Micro-generator:  
HSE Certificate of Exemption (August 2008).....60
  - A.1 Annex A1 Requirements for Type Testing of Inverter Connected Micro-  
generators .....61
  - A.2 Annex A2 Requirements for Type Testing of Synchronous and non-Inverter  
Micro-generators.....72

## Foreword

This Engineering Recommendation (EREC) G98 is published by the Energy Networks Association (ENA) and comes into effect on 27 April 2019 for **Micro-generators** commissioned on or after that date. The definition of **Micro-generators** within this document includes **Electricity Storage** devices and hence this document also applies to **Electricity Storage** devices (including any electric vehicle operating in vehicle to grid mode, but not otherwise) when operating in an export mode<sup>1</sup>. The applicability of the requirements in this document to **Electricity Storage** depend on the date on which the **Electricity Storage** devices are commissioned as detailed in paragraph 2.2.

It should be noted that there is likely to be a new requirement for **Electricity Storage** devices when operating in an import mode to switch to an export mode of operation when the system frequency falls below a defined threshold. In this case, the requirement would apply when the **Electricity Storage** device(s) is operating in import mode. The specifics of the requirement for both falling frequency and during system recovery are being considered by a NETSO working group and are not yet mandatory. The likely future requirement for **Electricity Storage** devices to transition from importing to exporting is described as an optional performance characteristic in this EREC G98. The NETSO working group is expected to confirm the characteristic described here, and to define the requirements as the frequency recovers. It is currently expected that the NETSO working group will conclude during 2022, following which the requirement, or something similar, will become mandatory.

This document has been prepared and approved under the authority of the **Great Britain Distribution Code Review Panel**. This EREC G98 has been written to take account of the EU Network Code on Requirements for Grid Connection of Generators 14 April 2016.

**Micro-generators** shall meet all of the requirements set out in this document. They shall have the formal status of **Fully Type Tested** and have provided proof that the requirements have been met.

In order to conform to this EREC G98, the relevant part of the **Customer Installation** shall conform to the requirements of EN 50549-1 as applicable to **Micro-generating Plant** together with additional or specific requirements detailed in this document. The purpose of this EREC G98 is to explain the technical requirements for connection of **Micro-generators** for operation in parallel with a public **Low Voltage Distribution Network**, by addressing all technical aspects of the connection process, from standards of functionality to on-site commissioning.

The procedures described are designed to facilitate the connection of **Micro-generators** whilst maintaining the integrity of the **GB public Low Voltage Distribution Network**, both in terms of safety and supply quality.

This EREC G98 provides sufficient information to allow:

---

<sup>1</sup> **Electricity Storage** devices shall meet the requirements of this EREC G98 but are not subject to the requirements of European Regulation (EU) 2016/631, European Regulation (EU) 2016/1388 and European Regulation EU 2016/1485. The requirements of this EREC G98 shall therefore be complied with by **Electricity Storage** devices under EREC G98 (and not under any of the aforementioned European Regulations). Any derogation sought for an **Electricity Storage** device shall be deemed a derogation from this EREC G98 only (and not from the aforementioned European Regulations).

- a) **Micro-generator Manufacturers** to design and market a product that is suitable for connection to the **GB public Low Voltage Distribution Network**; and
- b) **Customers, Manufacturers and Installers of Micro-generators** to be aware of the requirements of the **Distribution Network Operator (DNO)** before the **Micro-generator** installation will be accepted for connection to the **DNO's Distribution Network**.



## 1 Legal aspects

- 1.1. In accordance with the **Electricity Safety, Quality and Continuity Regulations (ESQCR)** Regulation 22(2)(c) and the exemption to **ESQCR** Regulation 22(2) (c) granted in August 2008 by the Health & Safety Executive the **Installer** is required to ensure that the **DNO** is made aware of the **Micro-generator** installation before the time of commissioning or no later than 28 days (inclusive of the day of commissioning) after commissioning.
- 1.2. The **DNO** is under a legal obligation to disallow the connection of **Micro-generating Plant** unless it complies with this EREC G98 and relevant legal requirements such as the Distribution Code and the **ESQCR**.
- 1.3. Under the terms of **ESQCR** Regulation 26 the **DNO** may require a **Micro-generator** to be disconnected if it is a source of danger or interferes with the quality of supply to other consumers.
- 1.4. In addition to the requirements specified in this document which allows connection to the **GB** public **Low Voltage Distribution Network**, the **Micro-generator** and all of its components shall conform to all relevant legal compliance and safety requirements.
- 1.5. This document does not remove any statutory rights of an individual or organisation; equally it does not remove any statutory obligation on an individual or organisation.

## 2 Scope

- 2.1 This EREC G98 provides guidance on the **GB** technical requirements for the connection of **Micro-generators** in parallel with public **Low Voltage Distribution Networks**. The requirements set out in this EREC G98 are in addition to those of European standard EN 50549-1 which should be complied with as applicable to **Micro-generating Plant**.
- 2.2 This EREC G98 applies in full to including **Electricity Storage** devices commissioned on or after 01 September 2022. **Micro-generating Plant** including **Electricity Storage** devices commissioned before 01 September 2022 shall comply with this EREC G98 taking account of the specific exclusions for **Electricity Storage** in Appendix 1.
- 2.3 There are two connection procedures described in this document. The first connection procedure covers the connection of a single **Micro-generating Plant**. A **Micro-generating Plant** is a single electrical installation that contains one or more **Micro-generators**, either single or multi-phase, the aggregate **Registered Capacity** of which is no greater than 16 A per phase<sup>2</sup>. The second connection procedure covers the connection of multiple **Micro-generators** (other than within a single **Customer's Installation**) in a **Close Geographic Region**, under a planned programme of work.
- 2.4 This document is applicable to **Fully Type Tested Micro-generators** for which a **Micro-generator Type Test Verification Report** demonstrates that the **Micro-generator** design meets all the requirements set out in this EREC G98. For **Micro-generators** greater than 16 A per phase the procedures described in EREC G99 apply.
- 2.5 Where a **Customer**:
- has an existing **Micro-generator** that conforms with the EREC G83 or EREC G98 requirements, and they wish to install an **Electricity Storage** device via an EREC G98 **Fully Type Tested Inverter** that is separate from the existing **Micro-generator Inverter**; or
  - wishes to install both a new **Micro-generator** (non-**Electricity Storage**) that conforms with the EREC G98 requirements, and an **Electricity Storage** device via a G98 **Fully Type Tested Inverter** together with an export limitation scheme that conforms with the EREC G100 requirements;

reference should be made to EREC G99 as the integrated micro generation and storage procedure may be appropriate. The integrated micro generation and storage procedure does not apply where the total aggregate capacity of the **Micro-generators** (both non-**Electricity Storage** and **Electricity Storage** devices) is less than or equal to 16 A per phase, when this EREC G98 applies.

- 2.6 For the purposes of this EREC G98 the **Registered Capacity** of 16 A per phase, single or multi-phase, 230/400 V **AC** corresponds to 3.68 kilowatts (kW) on a single-phase

---

<sup>2</sup> The **Manufacturer** may restrict the rating of the **Micro-generator** by applying software settings provided these settings are not accessible to the **Customer**.

supply and 11.04 kW on a three-phase supply. The kW rating shall be based on the nominal voltage (ie 230 V) as defined in BS EN 50160 and the **ESQCR**.

- 2.7 Where there is an existing **Micro-generator** commissioned under EREC G83, any additional **Micro-generators** will be treated separately. Only the additional **Micro-generators** need to conform to EREC G98. However, if the total aggregate capacity of the installation exceeds 16 A per phase the EREC G99 process applies and the **DNO** needs to be consulted before the installation is undertaken.
- 2.8 Where **Micro-generators** form part of a combined heat and power facility the impact on the **DNO's Distribution Network** shall be assessed on the basis of their electrical **Registered Capacity**.
- 2.9 For the avoidance of doubt where a **Customer's Installation** comprises a single **Connection Point** and more than one **Inverter**, which have an aggregate **Registered Capacity** of less than or equal to 16 A per phase, single or multi- phase, 230/400 V **AC**; the installation shall be considered as a single **Micro-generating Plant**.
- 2.10 This EREC G98 only specifies the requirements applicable to those **Micro-generators** that are designed to normally operate in parallel with a public **Low Voltage Distribution Network**. Those installations that are designed to operate in parallel with the **DNO's Distribution Network** for short periods (ie less than 5 minutes per month) or as an islanded installation should refer to EREC G99 as they are considered to be out of scope of this EREC G98, on the basis that it is not possible to devise generic rules that will ensure safe operation under all operating conditions.
- 2.11 Appendix 3 contains pro forma that relate to the connection, commissioning, testing, and decommissioning of **Micro-generators**.
- 2.12 Annexes A1 and A2 of this EREC G98 describe a methodology for testing various types of electrical interface between the **Micro-generator** and the public **Low Voltage Distribution Network**. The purpose of these type tests is to demonstrate compliance with the requirements of this EREC G98. The **Micro-generator** can be considered an approved **Micro-generator** for connection to the **GB public Low Voltage Distribution Network** by:
  - completing the **Type Test Verification Report** in Appendix 3 Form C of this EREC G98; and
  - satisfying the tests in Annex A1 (for **Inverter** connected **Micro-generators**) or Annex A2 (for synchronous **Micro-generators**) of this EREC G98 as appropriate.
- 2.13 A **Manufacturer** of a **Fully Type Tested Micro-generator** should allocate a **Manufacturer's** reference number, which should be registered on the Energy Networks Association (ENA) Type Test Register as the system reference. It is not

necessary for **Manufacturers of Fully Type Tested Micro-generators** to complete a **Type Test Verification Report**, Appendix 3 Form C, for each **Installation**.

2.14 **Connection Agreements**, energy trading and metering are considered to be out of scope. These issues are mentioned in this document only in the context of raising the reader's awareness to the fact that these matters might need to be addressed.

2.15 For **Micro-generating Plant** with a **Registered Capacity** of < 800 W and **Micro-generators** classified as emerging technology, some clauses of this EREC G98 shall not apply. Details of emerging technology and their requirements are given in Appendix 1. The exclusions for **Micro-generating Plant** with a **Registered Capacity** of < 800 W are also given in Appendix 1.

2.16 The structure of this document is as follows:

<b>Section</b>	<b>Subject</b>	<b>Applicable parties</b>
-	Foreword	All
1	Legal Aspects	All
2	Scope	All
3	References	All
4	Terms and Definitions	All
5	Connection Process and Testing Requirements	<b>Customer, Installer, Manufacturer, DNO</b>
6	Certification Requirements	<b>Manufacturer, DNO</b>
7	Operation and Safety	<b>Customer, Installer, DNO, Manufacturer</b>
8	Commissioning, Notification and Decommissioning	<b>Customer, Installer, DNO</b>
9	General Technical Requirements	<b>Manufacturer</b>
10	<b>Interface Protection</b>	<b>Manufacturer</b>
11	Quality of Supply	<b>Manufacturer, DNO</b>
12	Short Circuit Current Contribution	<b>Manufacturer, DNO</b>
Appendix 1	Emerging Technologies and other Exceptions	Emerging Technology Manufactures, <b>Manufacturer</b>
Appendix 2	Connection Procedure Flow Chart	<b>Customer, Installer, DNO</b>

Section	Subject	Applicable parties
Appendix 3	<b>Micro-generator</b> Documentation	All
Form A	Application for connection	<b>Customer, Installer, DNO</b>
Form B	Installation Document	<b>Customer, Installer, DNO</b>
Form C	<b>Type Test Verification Report</b>	<b>Customer, Installer, DNO</b>
Form D	Decommissioning Confirmation	<b>Customer, Installer, DNO</b>
Appendix 4	Certificate of Exemption	<b>Customer, Installer, DNO</b>
Annex A1	Requirements for Testing of <b>Inverter</b> Connected <b>Micro-generators</b>	<b>Manufacturer</b>
Annex A2	Requirements for Testing of <b>Synchronous Micro-generators</b>	<b>Manufacturer</b>

2.17 **Micro-generators** that have been **Fully Type Tested** to demonstrate compliance with previous amendments of EREC G98 remain valid for this current version of EREC G98.

### 3 References

The following referenced documents, in whole or part, are indispensable for the application of this document. It is expected that it will be appropriate to use the most recent version of the documents below. Where any conflict arises the version in place at the time of commissioning of the **Micro-generator** shall take precedence.

#### 3.1 Regulations and Directives

##### **Electricity Safety, Quality and Continuity Regulations (ESQCR)**

The Electricity Safety, Quality and Continuity Regulations 2002 - Statutory Instrument Number 2665 -HMSO ISBN 0-11-042920-6 abbreviated to ESQCR in this document.

##### **Commission Regulation (EU) No 2016/631**

Establishing a network code on Requirements for Grid Connection of Generators.

##### **Directive 2009/72/EC of the European Parliament and of the Council**

Concerning common rules for the internal market in electricity and repealing Directive 2003/54/EC.

##### **Regulation (EC) No 714/2009 of the European Parliament and of the Council**

on conditions for access to the network for cross-border exchanges in electricity and repealing Regulation (EC) No 1228/2003.

##### **Regulation (EC) No 765/2008 of the European Parliament and of the Council**

Setting out the requirements for accreditation and market surveillance relating to the marketing of products and repealing Regulation (EEC) No 339/93.

### 3.2 Standards publications

#### **BS 7671 Requirements for Electrical Installations**

IET Wiring Regulations.

#### **BS EN 50160**

Voltage characteristics of electricity supplied by public electricity networks.

#### **EN 50549-1**

Requirements for generating plants to be connected in parallel with distribution networks, Part 1: Connection to a LV distribution network - Generating plants up to and including Type B.

#### **BS EN 60034-4**

Rotating electrical machines. Methods for determining synchronous machine quantities from tests.

#### **BS EN 60255 series\***

Measuring relays and protection equipment.

#### **BS EN 60664-1**

Insulation coordination for equipment within low-voltage systems – Part 1: Principles, requirements and tests (IEC 60664-1).

#### **BS EN 60947 series\***

Low-voltage switchgear and control gear.

#### **BS EN 61000 series\***

Electromagnetic Compatibility (EMC).

#### **BS EN 61000-3-2**

Limits for harmonic current emissions (equipment input current up to and including 16 A per phase).

#### **BS EN 61000-3-3**

Electromagnetic compatibility (EMC) Limits – Limitation of voltage changes, voltage fluctuations and flicker in public low-voltage supply systems, for equipment with rated current < 16A per phase and not subject to conditional connection.

#### **BS EN 61508 series\***

Functional safety of electrical/ electronic/ programmable electronic safety-related systems.

#### **BS EN 61810 series\***

Electromechanical Elementary Relays.

#### **BS EN 62116**

Test procedure of islanding prevention measures for utility-interconnected photovoltaic Inverters.

#### **IEC 60725**

Considerations or reference impedances for use in determining the disturbance characteristics of household appliances and similar electrical equipment.

**IEC 60909-1**

Short circuit calculation in three-phase AC systems.

**IEC 62282-3-2**

Fuel cell technologies - Part 3-2: Stationary fuel cell power systems - Performance test methods.

***\*Where standards have more than one part, the requirements of all such parts shall be satisfied, so far as they are applicable.***

**3.3 Other publications**

**Engineering Recommendation G5**

Harmonic voltage distortion and the connection of harmonic sources and/or resonant plant to transmission systems and distribution networks in the United Kingdom.

**Engineering Recommendation G99**

Requirements for the connection of generation equipment in parallel with public distribution networks on or after 27 April 2019.

**Engineering Recommendation P28**

Voltage fluctuations and the connection of disturbing equipment to transmission systems and distribution networks in the United Kingdom.

**Engineering Recommendation P29**

Planning limits for voltage unbalance in the UK for 132kV and below.

**Engineering Recommendation G74**

Procedure to meet the requirements of IEC 60909 for the calculation of short-circuit currents in three-phase AC power systems.

**Engineering Recommendation G100**

Technical Guidance for Customer Export Limiting Schemes.

**ENA and Department for Business, Energy and Industrial Strategy (BEIS) Distributed Energy Resources (DER) – Cyber Security Connection Guidance**

Guidance to support users in the design, development, deployment, connection and maintenance of new and existing DERs to the distribution networks to improve their cyber security.

**Publicly Available Specification (PAS) 1879**

Energy smart appliances – Demand side response operation – Code of practice.

## 4 Terms and definitions

For the purposes of this document, the following terms and definitions apply.

### **Active Power (P)**

The product of voltage and the in-phase component of alternating current measured in units of watts, normally measured in kilowatts (kW) or megawatts (MW).

### **Active Power Frequency Response**

An automatic response of **Active Power** output, from a **Micro-generator**, to a change in system frequency.

### **Close Geographic Region**

Either:

- a) The area served by a single **Low Voltage** feeder circuit fed from a single distribution transformer; or
- b) An area confirmed by the **DNO** on request; or
- c) An area that meets at least one of the following criteria:
  - 1) The postcodes of any of the premises where a **Micro-generator** installation is planned by the same organisation are the same when the last two letters are ignored; ie AB1 2xx, where xx could be any pair of letters or where x could be any letter.
  - 2) The premises where a **Micro-generator** installation is planned by the same organisation are within 500 m of each other.

### **Connection Agreement**

A contract between the **Distribution Network Operator** and the **Customer**, which includes the relevant site and specific technical requirements for the **Micro-generating Plant**.

### **Connection Point**

The interface at which the **Customer's Installation** is connected to a **Distribution Network**, as identified in the **Connection Agreement**.

### **Controller**

A device for controlling the functional operation of a **Micro-generator**.

### **Customer**

A person who is the owner or occupier of premises that are connected to the **Distribution Network**.



## **Customer's Installation**

The electrical installation on the **Customer's** side of the **Connection Point** together with any equipment permanently connected or intended to be permanently connected thereto.

## **Direct Current or DC**

The movement of electrical current flows in one constant direction, as opposed to Alternating Current or AC, in which the current constantly reverses direction.

## **Distribution Code Review Panel**

The standing body established under the Distribution Code.

## **Distribution Network**

An electrical **Network** for the distribution of electrical power from and to third party[s] connected to it, a transmission or another **Distribution Network**.

## **Distribution Network Operator (DNO)**

The person or legal entity named in of a distribution licence and any permitted legal assigns or successors in title of the named party. A distribution licence is granted under Section 6(1)(c) of the Electricity Act 1989 (as amended by the Utilities Act 2000 and the Energy Act 2004).

## **Droop**

The ratio of the per unit steady state change in speed, (or frequency), to the per unit steady state change in **Active Power** output. Whilst not mandatory, it is often common practice to express **Droop** in percentage terms.

## **DNO's Distribution Network**

The system consisting (wholly or mainly) of electric lines owned or operated by the **DNO** and used for the distribution of electricity.

## **Electricity Safety, Quality and Continuity Regulations (ESQCR)**

The statutory instrument entitled The **Electricity Safety, Quality and Continuity Regulations** 2002 as amended from time to time and including any further statutory instruments issued under the Electricity Act 1989 (as amended by the Utilities Act 2000 and the Energy Act 2004) in relation to the distribution of electricity.

## **Electricity Storage**

**Electricity Storage** in the electricity system is the conversion of electrical energy in to a form of energy which can be stored, the storing of that energy, and the subsequent reconversion of that energy back into electrical energy. In this context an **Electricity Storage** device includes electric vehicles if configured to work in vehicle to grid mode, ie acting as source of electrical energy supply to the **Customer's Installation** and/or the **DNO's Distribution Network**.

## **Fully Type Tested**

A **Micro-generator** which has been tested to ensure that the design meets the relevant technical and compliance requirements of this EREC G98, and for which the **Manufacturer** has declared that all similar **Micro-generators** supplied will be

constructed to the same standards and will have the same performance. In the case where **Interface Protection** functionality is included in the tested equipment, all similar products will be manufactured with the same protection settings as the tested product.

### **Great Britain or GB**

The landmass of England & Wales and Scotland, including internal waters.

### **Installation Document**

A simple structured document containing information about a **Micro-generator** and confirming its compliance with the relevant requirements set out in this EREC G98.

### **Installer**

The person who is responsible for the installation of the **Micro-generator(s)**.

### **Interface Protection**

The electrical protection required to ensure that any **Micro-generator** is disconnected from the **Distribution Network** for any event that could impair the integrity or degrade the safety of the **Distribution Network**. **Interface Protection** may be installed on each **Micro-generator** or at the **Connection Point** for the **Micro-generating Plant**.

### **Inverter**

A device for conversion from **Direct Current** to nominal frequency Alternating Current.

### **Limited Frequency Sensitive Mode - Overfrequency (LFSM-O)**

A **Micro-generator** operating mode which will result in **Active Power** output reduction in response to a change in system frequency once the system frequency exceeds a certain value.

### **Low Voltage or LV**

A voltage normally exceeding extra-low voltage (50 V) but not exceeding 1000 V AC or 1500 V **DC** between conductors or 600 V AC or 900 V **DC** between conductors and earth.

### **Manufacturer**

A person or organisation that manufactures **Micro-generators**, and also 'packages' components manufactured by others to make **Micro-generators**, which can be **Fully Type Tested** to meet the requirements of this EREC G98.

### **Micro-generating Plant**

An electrical installation with one or more **Micro-generators** with nominal currents in sum not exceeding 16 A per phase.

### **Micro-generator**

A source of electrical energy and all associated interface equipment able to be connected to an electric circuit in a **Low Voltage** electrical installation and designed to operate in parallel with a public **Low Voltage Distribution Network** with nominal currents up to and including 16 A per phase.

For the avoidance of doubt this includes **Electricity Storage** devices.

### **Registered Capacity**

The normal full load capacity of a **Micro-generator**, as declared by the **Manufacturer** which should exclude the **Active Power** consumed by the **Micro-generator** when producing the **Registered Capacity**; ie this will relate to the maximum level of **Active Power** deliverable from the **Micro-generating Plant**. For **Micro-generators** connected to the **DNO's Distribution Network** via an **Inverter**, the **Registered Capacity** of the **Micro-generator** is the lesser of the **Inverter(s)** rating or the rating of the energy source<sup>3</sup>.

### **Type Test Verification Report**

A report compiled by the **Manufacturer** that can be used to demonstrate compliance with this document.

## **5 Connection Procedure**

### **5.1 Single Premises Connection Procedure**

5.1.1 In most instances the installation of **Micro-generating Plant**, the aggregate **Registered Capacity** of which is no greater than 16 A per phase, connected in parallel with the public **Low Voltage Distribution Network**, will have negligible impact on the operation of the public **Low Voltage Distribution Network**; as such there will be no need for the **DNO** to carry out detailed network studies to assess the impact of the connection. As required by the **ESQCR** Certificate of Exemption (2008) the **Installer** shall provide the **DNO** with all necessary information on the installation no later than 28 days after the **Micro-generating Plant** has been commissioned; the format and content shall be as shown in Appendix 3 Form B **Installation Document**.

5.1.2 This procedure will not apply where an **Installer** plans (within the next 28 days) or has already installed (in the previous 28 days) other **Micro-generating Plants** in a **Close Geographic Region**; in this case the procedure in 5.2 shall be followed. Failure to comply with this requirement may lead to the disconnection of the **Micro-generating Plant** under **ESQCR** (26) or failure of the **Micro-generating Plant** to operate as intended.

### **5.2 Multiple Premises Connection Procedure**

5.2.1 In the case of projects where the proposal is to install single or multiple **Micro-generators** in a number of **Customer Installations** in a **Close Geographic Region**, the **Installer** shall discuss the installation project with the local **DNO** at the earliest opportunity. The **DNO** will need to assess the impact that these connections may have on the **Distribution Network** and specify conditions for connection. The initial application will need to be in a format similar to that shown in Appendix 3 Form A. Connection of the **Micro-generator** is only allowed after the application for connection has been approved by the **DNO** and any **DNO** works facilitating the connection have been completed. Confirmation of the commissioning of each **Micro-generator** will

---

<sup>3</sup> The **Manufacturer** may restrict the rating of the **Micro-generator** by applying software settings provided these settings are not accessible to the **Customer**.

need to be made no later than 28 days after commissioning; the format and content shall be as shown in Appendix 3 Form B **Installation Document**.

5.2.2 Upon receipt of a multiple premises connection application the **DNO**'s response will be in accordance with the electricity generation standards set by the Authority for applications for connection to the **Distribution Network**.

### 5.3 **General**

5.3.1 It is the responsibility of the **Installer** to ensure that the relevant information as specified in this section and in section 6 is forwarded to the local **DNO** as appropriate. The pro formas in Appendix 3 are designed to:

- a) simplify the connection procedure for both **DNO** and **Micro-generator Installer**;
- b) provide the **DNO** with all the information required to assess the potential impact of the **Micro-generator** connection on the operation of the **Distribution Network**;
- c) inform the **DNO** that the **Micro-generator** installation complies with the requirements of this EREC G98; and
- d) allow the **DNO** to accurately record the location of all **Micro-generators** connected to the **Distribution Network**.

## 6 **Certification Requirements**

### 6.1 **Type Test Certification**

6.1.1 Type test certification is the responsibility of the **Manufacturer**. The **Manufacturer** shall make available upon request a **Type Test Verification Report** confirming that the **Micro-generator** has been tested to satisfy the requirements of this EREC G98. The report shall detail the type and model of **Micro-generator** tested, the test conditions and results recorded. All of these details shall be included in a **Type Test Verification Report**. The required verification report and declaration are shown in Appendix 3 Form C. It is intended that **Manufacturers** of **Micro-generators** will use the requirements of this EREC G98 to develop type verification certification for each of their **Micro-generator** models.

6.1.2 **Manufacturers** of a **Fully Type Tested Micro-generator** should allocate a **Manufacturer's** reference number and register this together with the required details of the **Micro-generator** with the Energy Networks Association Type Test register.

## 6.2 Compliance

6.2.1 Compliance with the requirements detailed in this EREC G98 will ensure that the **Micro-generator(s)** is considered to be approved for connection to the **DNO's Distribution Network**.

6.2.2 The **Micro-generator(s)** shall conform to all relevant compliance and safety legislation.

## 6.3 Family approach to Type Testing

6.3.1 A family approach to type testing is acceptable, whereby **Micro-generators** that are the same model and produced by the same **Manufacturer** but vary in electrical output can be considered to be **Fully Type Tested** once one **Micro-generator** in the family has been shown to be compliant.<sup>4</sup> The approach is permissible in the following range of **Micro-generator** electrical output:

- For synchronous **Micro-generators**:
  - Lower limit:  $1/\sqrt{10}$  (0.3162) times the tested **Micro-generator** nameplate rating (W)
  - Upper limit:  $\sqrt{10}$  (3.162) times the tested **Micro-generator** nameplate rating (W)
- For all other **Micro-generators**:
  - Lower limit:  $1/\sqrt{10}$  (0.3162) times the tested **Micro-generator** nameplate rating (W)
  - Upper limit: 2 times the tested **Micro-generator** nameplate rating (W)

6.3.2 All absolute values (e.g. operating range tests) from the tested **Micro-generator** shall be transferred directly in the compliance forms of an assumed compliant **Micro-generator** of the same family. All relative results related to design **Active Power** or current (e.g. power quality fluctuation and flicker) from the tested **Micro-generator** shall be transferred to the compliance form of a **Micro-generator** in the same family according to the ratio of the respective nameplate rating (W) of the tested **Micro-generator** and the assumed compliant **Micro-generator**. For the avoidance of doubt, the **Manufacturer** shall register each **Micro-generator** in the family on the Energy Networks Association Type Test register.

6.3.3 It is the responsibility of the **Manufacturer** to provide technical justification that the results are transferable. For example, the **Micro-generators** have the same control systems.

---

<sup>4</sup> This approach is taken in Germany by VDE, a standards, testing and certification institution.

## 7 Operation and Safety

### 7.1 Operational Requirements

7.1.1 Compliance with this EREC G98 in respect of the design, installation, operation and maintenance of a **Micro-generating Plant**, will ensure that the **Customer** is discharging their legal obligations under **ESQCR 22(1)(a)** and the EU Network Code on Requirements for Grid Connection of Generators.

### 7.2 Installation Wiring and Isolation

7.2.1 The installation that connects the **Micro-generating Plant** to the **Connection Point** shall comply with the requirements of BS 7671. All wiring between the **Connection Point** and the **Micro-generator(s)** shall be protected by a suitably rated protective device and shall be of suitable size and type for the rating of the **Micro-generator**. The **Micro-generator(s)** shall be connected via an accessible isolation switch that is capable of isolating all phases and neutral. The isolation switch shall be capable of being secured in the 'off' (isolated) position.

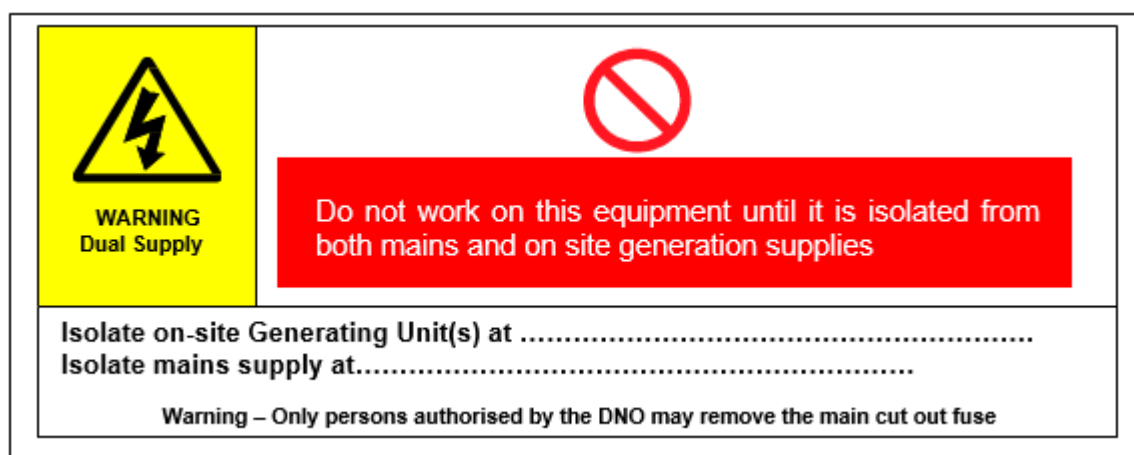

Figure 1 – Example of a Warning Label

### 7.3 Labelling

7.3.1 The **Installer** shall provide labelling at the **Connection Point** with the **DNO's Distribution Network** (cut-out), meter position, consumer unit and at all points of isolation between the **Connection Point** and the **Micro-generating Plant** within the **Customer's** premises to indicate the presence of a **Micro-generating Plant**. The labelling should be sufficiently robust and if necessary fixed in place to ensure that it remains legible and secure for the lifetime of the installation. Warning labels of the form shown in Figure 1 shall be used. It should be noted that the warning label does not imply a right on the **Customer**, **Installer** or maintainer to operate (remove / replace) the **DNO's** cut-out fuse and a note to this effect should be included on the warning label.

7.3.2 In addition to the warning label, this EREC G98 requires the following, up to date, information to be displayed at the **Connection Point** with the **DNO's Distribution Network**.

a) A circuit diagram relevant to the installation showing the circuit wiring, including

all protective devices, between the **Micro-generating Plant** and the **DNO's** fused cut-out. This diagram should also show by whom all apparatus is owned and maintained; and

- b) A summary of the **Interface Protection** settings incorporated within the **Micro-generator**.

7.3.3 Figure 2 shows an outline example of the type of circuit diagram that will need to be displayed. Figure 2 is non-prescriptive and is for illustrative purposes only.

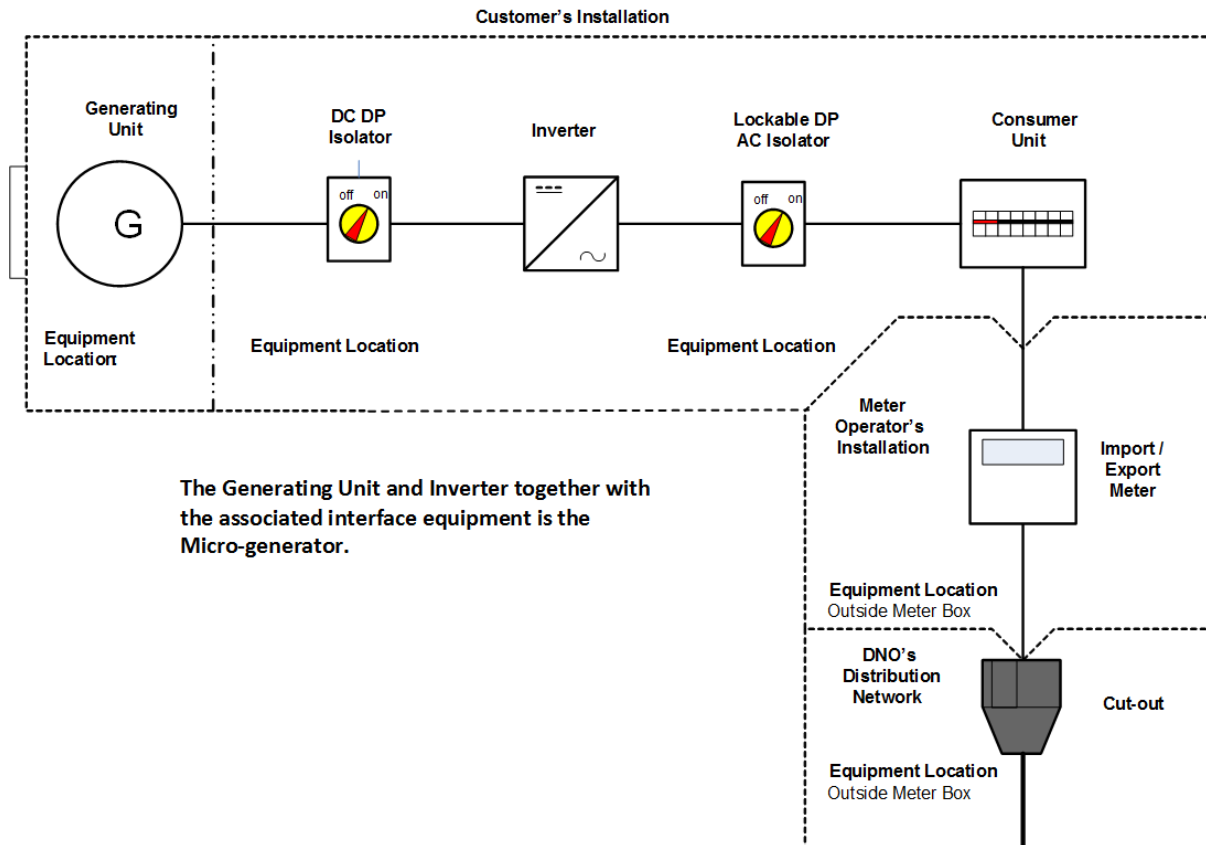

**Figure 2 – Example of the type of circuit diagram**

7.3.4 The **Installer** shall advise the **Customer** that it is the **Customer's** responsibility to ensure that this safety information is kept up to date. The installation operating instructions shall contain the **Manufacturer's** contact details eg name, telephone number and web address.

#### 7.4 Maintenance & Routine Testing

7.4.1 Periodic testing of the **Micro-generator** is recommended at intervals prescribed by the **Manufacturer**. This information shall be included in the installation and user

instructions. The method of testing and/or servicing should be included in the servicing instructions.

## 7.5 Phase Unbalance

- 7.5.1 There is no requirement to balance phases on installations below or equal to 16 A per phase.
- 7.5.2 For multiple premises installations of **Micro-generators** (eg new housing developments), balancing the **Micro-generators** evenly against the load on the three phases will need to be considered by the **DNO**. The **DNO** will advise the **Installer** of any phase balancing requirements.

## 7.6 Voltage Management Units

- 7.6.1 If a Voltage Management Unit is installed in a **Customer's Installation** between the **Connection Point** and the **Micro-generator**, it may result in the voltage at the **Micro-generator** side of the Voltage Management Unit remaining within the limits of the protection settings defined in Table 2 while the voltage at the **Connection Point** side of the unit might be outside the limits of the protection settings. This would negate the effect of the protection settings. Therefore, this connection arrangement is not acceptable and all **Micro-generators** connected to the **DNO's LV Distribution Network** under this EREC G98 shall be made on the **Connection Point** side of any Voltage Management Unit installed in a **Customers' Installation**.

## 7.7 Earthing

- 7.7.1 There shall be no direct connection between the **Micro-generator** current carrying conductors and earth with the following exception:
- For a **Micro-generator** that is connected via an **Inverter** (eg a PV array or fuel cell) it is permissible to connect one pole of the **DC** side of the **Inverter** to the **DNO's** earth terminal if the insulation between the AC and the **DC** sides of the **Inverter** meets the requirements for at least simple separation. The requirements for simple separation are those given in Section 5.3.3 of BS EN 60664-1 for basic insulation. In such cases the **Installer** shall take all reasonable precautions to ensure that the **Micro-generating Plant** will not impair the integrity of the **DNO's Distribution Network** and will not suffer unacceptable damage for all credible operating conditions, including faults on the **DNO's Distribution Network**.
- 7.7.2 Earthing of all exposed conductive parts shall comply with the requirements of BS 7671.

## 8 Commissioning, Notification and Decommissioning

### 8.1 General

- 8.1.1 The installation shall be carried out by **Installers** who are competent and have sufficient skills and training (complete with recognised and approved qualifications relating to the fuels used and general electrical installations) to apply safe methods of work to install a **Micro-generator** in compliance with this EREC G98.



Notwithstanding the requirements of this EREC G98, the installation will be carried out to no lower a standard than that required in the **Manufacturer's** installation instructions.

## 8.2 Commissioning

- 8.2.1 No parameter relating to the electrical connection and subject to type verification certification shall be modified unless previously agreed in writing between the **DNO** and the **Customer** or their agent. **Customer** access to such parameters shall be prevented.
- 8.2.2 As part of the on-site commissioning tests the **Installer** shall carry out a functional check of the loss of mains protection, for example by removing the supply to the **Micro-generator** during operation and checking that the **Interface Protection** operates to disconnect the **Micro-generator** from the **DNO's Distribution Network**. For three phase installations this test can be achieved by opening a three phase circuit breaker or isolator and confirming that the **Micro-generator** has shut down. Testing for the loss of a single phase is covered in the type testing of **Inverters**, see section 10.2.

## 8.3 Notification of Commissioning

- 8.3.1 In accordance with **ESQCR** and the HSE Certificate of Exemption (2008) (see Appendix 4) the **Installer** shall ensure that the **DNO** is advised of the intention to use the **Micro-generator** in parallel with the **Distribution Network** no later than 28 days (inclusive of the day of commissioning) after commissioning the **Micro-generator**. Notification that the **Micro-generator** has been commissioned is achieved by completing an **Installation Document** as per Appendix 3 Form B (**Installation Document**), which also includes the relevant details on the **Micro-generator** installation required by the **DNO**.
- 8.3.2 The **Installer** shall supply separate **Installation Documents** for each premises in which **Micro-generators** are installed under EREC G98. Documentation may be submitted via an agent acting on behalf of the **Installer** and may be submitted electronically.

## 8.4 Notification of Changes

- 8.4.1 If a **Micro-generator** requires modification the **Manufacturer** shall re-submit the **Type Test Verification Report** prior to the modification being made and the **Micro-generator** being recommissioned.
- 8.4.2 The **DNO** shall be notified of any operational incidents or failures of a **Micro-generator** that affect its compliance with this EREC G98, without undue delay, after the occurrence of those incidents.
- 8.4.3 The **DNO** shall have the right to request that the **Customer** arrange to have compliance tests undertaken after any failure, modification or replacement of any equipment that may have an impact on the **Micro-generator's** compliance with this EREC G98.
- 8.4.4 Where an existing **Micro-generator** installed under EREC G83 is substantially modified (eg a significant piece of equipment, such as an inverter, is replaced) then it will be necessary for that **Micro-generator** to be modified to be compliant with this

EREC G98. Modifications to an existing **Micro-generator** which complies with the requirements of EREC G83 that are not considered to be substantial do not change the compliance requirements of that **Micro-generator**, ie it can remain compliant with EREC G83.<sup>5</sup>

## 8.5 Notification of Decommissioning

- 8.5.1 The **Customer** shall notify the **DNO** about the permanent decommissioning of a **Micro-generator** by providing the information as detailed under Appendix 3 Form D. Documentation may be submitted by an agent acting on behalf of the **Customer** and may be submitted electronically.

---

<sup>5</sup> EREC G99 Annex A.6 provides guidance on modifications that are considered substantial. While this is aimed at larger generation installations than this EREC G98, some of the guidance may be helpful in establishing whether a modification is considered to be substantial.

## 9 General Technical Requirements

### 9.1 Frequency withstand

- 9.1.1 The **Micro-generator** shall be capable of remaining connected to the **Distribution Network** and operating within the frequency ranges and time periods specified in Table 1 unless disconnection was triggered by rate-of-change-of-frequency-type loss of mains protection.

**Table 1 – Minimum time periods for which a Micro-generator has to be capable of operating within different frequency ranges without disconnecting from the Distribution Network**

47.0 Hz – 47.5 Hz	20 seconds
47.5 Hz – 48.5 Hz	90 minutes
48.5 Hz -49.0 Hz	90 minutes
49.0 Hz – 51.0 Hz	Unlimited
51.0 Hz – 51.5 Hz	90 minutes
51.5 Hz – 52.0 Hz	15 minutes

### 9.2 Rate of Change of Frequency

- 9.2.1 With regard to the rate of change of frequency withstand capability, a **Micro-generator** shall be capable of staying connected to the **Distribution Network** and operate at rates of change of frequency up to  $1.0 \text{ Hzs}^{-1}$  measured over 500 ms.

### 9.3 Limited Frequency Sensitive Mode – Overfrequency

- 9.3.1 With regard to the **Limited Frequency Sensitive Mode — Overfrequency (LFSM-O)**, the **Micro-generator** shall be capable of reducing its **Active Power** output when the frequency rises above 50.4 Hz. The **Droop** shall be 10%. No intentional delay should be programmed to ensure that the initial delay is as short as possible with a maximum of 2 s.
- 9.3.2 The **Micro-generator** shall continue to reduce its **Active Power** output with rising frequency with a **Droop** of 10% until 52.0 Hz, at which point the **Micro-generator** should disconnect.
- 9.3.3 If the reduction in **Active Power** output is such that the **Micro-generator** reaches its minimum stable operating level, it shall continue to operate stably at this level.
- 9.3.4 Steady state operation below a **Micro-generator's** minimum stable operating level is not expected but if system frequency would cause operation below its minimum stable

operating level then the **Micro-generator** shall be able to deliver an output of not less than the minimum stable operating level.

#### 9.4 Active Power Output

9.4.1 The **Micro-generator** shall be capable of maintaining constant **Active Power** output at its **Registered Capacity** regardless of changes in frequency, except where the output follows the changes defined in the context of paragraphs 9.3.1 and 9.4.2.

9.4.2 The **Micro-generator** shall be capable of maintaining constant **Active Power** output at its **Registered Capacity** regardless of changes in frequency in the range 49.5 – 50.4 Hz. Below 49.5 Hz, the **Active Power** output should not drop by more than pro-rata with frequency, ie the maximum permitted requirement is 100% power at 49.5 Hz falling linearly to 95% power at 47.0 Hz as illustrated in Figure 3.

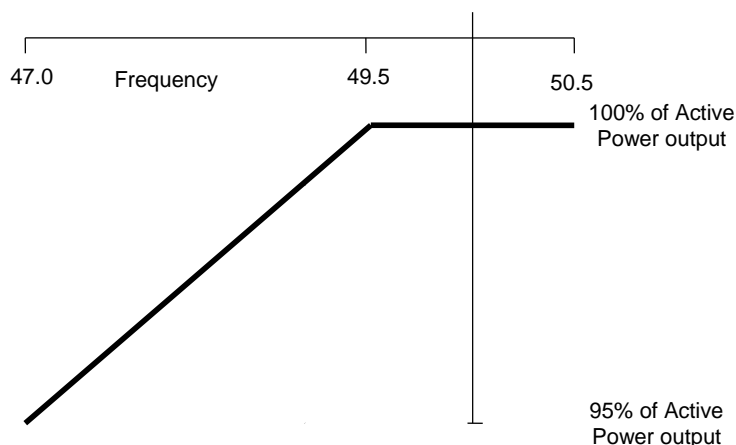
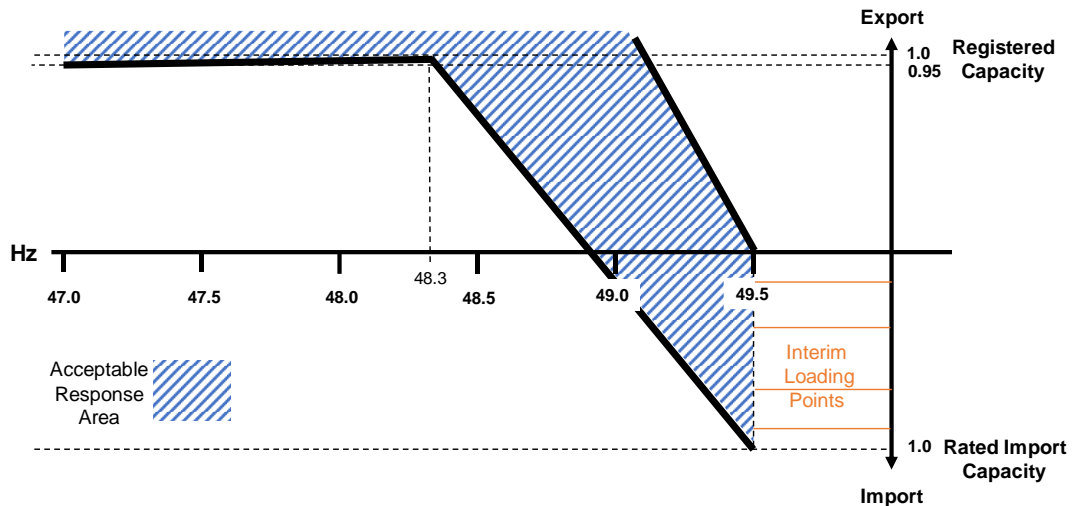

**Figure 3 – Change in Active Power output with falling frequency**

9.4.3 This paragraph describes an optional performance characteristic as discussed in the foreword. A **Micro-generating Plant** that incorporates an **Electricity Storage** device can support the **Total System** by being arranged to automatically respond to falling frequency in line with the characteristic of Figure 4.

The required characteristics are:

- When the frequency falls to 49.5 Hz the automatic response shall start;
- The frequency response characteristic shall be within the shaded area of Figure 4;
- If the **Electricity Storage** device is not capable of moving from an import level to an appropriate export level within 20 s of the frequency falling to 49.2 Hz, then it shall cease to import; and
- If the **Electricity Storage** device has not achieved at least zero **Active Power** import when the frequency has reached 48.9 Hz it shall cease to import immediately.



**Figure 4 Change in Active Power of Electricity Storage with falling frequency (not to scale)**

9.4.4 The **Micro-generator** shall be equipped with a logic interface (input port) in order to cease **Active Power** output within 5 s following an instruction being received from the **DNO** at the input port. By default the logic interface will take the form of a simple binary output that can be operated by a simple switch or contactor. When the switch is closed the **Micro-generator** can operate normally. When the switch is opened the **Micro-generator** will reduce its **Active Power** to zero within 5 s. The signal from the **Micro-generator** that is being switched can be either AC (maximum value 240 V) or DC (maximum value 110 V). The **DNO** may specify any additional requirements particularly regarding remote operation of this facility.

## 9.5 Power Factor

9.5.1 The power factor capability of the **Micro-generator** shall conform to EN 50549-1 as applicable to **Micro-generating Plant**. When operating at **Registered Capacity** the **Micro-generator** shall operate at a power factor within the range 0.95 lagging to 0.95 leading relative to the voltage waveform unless otherwise agreed with the **DNO** eg for power factor improvement.

## 9.6 Automatic Connection

9.6.1 **Micro-generators** shall conform to EN 50549-1 in respect of connection and starting to generate electric power. Connection, reconnection and starting to generate electrical power is only allowed after the voltage and frequency at the **Connection Point** is within the limits of the **Interface Protection** settings for a minimum of 20 s.

## 9.7 Cyber Security

9.7.1 Every **Micro-generator** and any associated equipment must be designed and operated appropriately to ensure cyber security. The **Manufacturer** or **Installer** shall consider all cyber security risks applicable to the **Micro-Generator** both in terms of the communication between any home energy management system etc and also in terms of interaction with any system of the **Manufacturer** for product management.

9.7.2 The **Manufacturer** or **Installer** shall provide information describing the high level cyber security approach, as well as the specific cyber security requirements complied with.

The statement will make appropriate reference to the **Micro-generator's** compliance with

- ETSI EN 303 645;
- relevant aspects of PAS 1879 "Energy smart appliances – Demand side response operation – Code of practice";
- relevant aspects of "Distributed Energy Resources – Cyber Security Connection Guidance" published by BEIS and the ENA;
- Any other relevant standard that has been incorporated in the design of the **Micro-Generator**.

## 10 Interface Protection

### 10.1 General

- 10.1.1 The **Micro-generator** shall conform to the **Interface Protection** settings set out below (Table 2). Means shall be provided to protect the settings from unpermitted interference (eg via a password or seal).
- 10.1.2 The **DNO** is responsible under the **Distribution Code** for ensuring, by design, that the voltage and frequency at the **Connection Point** remains within statutory limits. The **Interface Protection** settings have been chosen to allow for voltage rise or drop within the **Customer's Installation** and to allow the **Micro-generator** to continue to operate outside of the statutory frequency range as required by the EU Network Code on Requirements for Grid Connection of Generators.
- 10.1.3 **Interface Protection** shall be installed which disconnects the **Micro-generator** from the **DNO's Distribution Network** when any parameter is outside of the settings shown in Table 2.

**Table 2 – Interface Protection settings**

Protection Function	Trip Setting	Time Delay Setting
U/V	$V_{\phi-n^{\dagger}} - 20\% = 184 \text{ V}$	2.5 s
O/V stage 1	$V_{\phi-n^{\dagger}} + 14\% = 262.2 \text{ V}$	1.0 s
O/V stage 2	$V_{\phi-n^{\dagger}} + 19\% = 273.7 \text{ V}^6$	0.5 s
U/F stage 1	47.5 Hz	20 s
U/F stage 2	47 Hz	0.5 s
O/F	52 Hz	0.5 s
LoM (RoCoF)	$1.0 \text{ Hzs}^{-1}$	

† A value of 230 V phase to neutral

- 10.1.4 The total disconnection time for voltage and frequency protection, including the operating time of the disconnection device, shall be the time delay setting with a tolerance of, -0 s + 0.5 s.
- 10.1.5 For the avoidance of doubt, where the **Distribution Network** voltage or frequency exceed the trip settings in Table 2, for less than the time delay setting, the **Micro-generator** should not disconnect from the **Distribution Network**.
- 10.1.6 **Fully Type Tested Micro-generators** shall have protection settings set during manufacture.

<sup>6</sup> For voltages greater than 230 V +19% which are present for periods of <0.5 s the **Micro-generator** is permitted to reduce/cease exporting in order to protect the equipment.

10.1.7 The **Manufacturer** shall establish a secure way of displaying the **Interface Protection** setting information in one of the following ways:

- A display on a screen;
- A display on a PC which can communicate with the **Micro-generator** and confirm that it is the correct **Micro-generator** by means of a serial number permanently fixed to the **Micro-generator** and visible on the PC screen at the same time as the settings; or
- Display of all **Interface Protection** settings and nominal voltage and current outputs, alongside the serial number of the **Micro-generator**, permanently fixed to the **Micro-generator**.

10.1.8 The provision of loose documents, documents attached to the **Micro-generator** by cable ties etc, or provision of data on adhesive paper based products which are not likely to survive due to fading, or failure of the adhesive, for at least 20 years is not acceptable.

10.1.9 In response to a protection operation the **Micro-generator** shall be automatically disconnected from the **DNO's Distribution Network**. This disconnection shall be achieved by the separation of mechanical contacts or alternatively by the operation of a suitably rated solid state switching device. Where a solid state switching device is used to afford disconnection of the **Micro-generator**, the switching device shall incorporate fail safe monitoring to check the voltage level at its output stage. In the event that the solid state switching device fails to disconnect the **Micro-generator**, the voltage on the output side of the switching device shall be reduced to a value below 50 V within 0.5 s of the protection and trip delay timer operation.

10.1.10 The **Interface Protection** shall function correctly, ie operate within the required tolerance range as given in paragraph 10.1.4, across the expected range of ambient operating temperatures and other environmental factors.

10.1.11 Where a common protection system is used to provide the protection function for multiple **Micro-generators** the complete installation cannot be considered to comprise **Fully Type Tested Micro-generators** if the protection and connections are made up on site and so cannot be factory tested or **Fully Type Tested**. In accordance with Annex A1 or Annex A2 if the units or **Micro-generators** are specifically designed with plugs and sockets to be interconnected on site, then provided the assembly passes the function tests required in Appendix 3 Form C, the **Micro-generator(s)** can retain **Fully Type Tested** status.

10.1.12 Once the **Micro-generator** has been installed and commissioned the protection settings shall only be altered following written agreement between the **DNO** and the **Customer** or their agent.

## 10.2 Loss of Mains Protection

10.2.1 Loss of mains protection shall be incorporated and tested as defined in the relevant compliance type testing annex of this EREC G98. Active methods which use impedance measuring techniques by drawing current pulses from or injecting AC currents into the **DNO's Distribution Network** are not considered to be suitable. For **Micro-generators** which generate on more than one phase, the loss of mains



protection should be able to detect the loss of a single phase of the supply network. This should be tested during type testing and recorded in the **Type Test Verification Report** as per Appendix 3 Form C.

### 10.3 Frequency Drift and Step Change Stability Test

- 10.3.1 Under normal operation of the **Distribution Network**, the frequency changes over time due to continuous unbalance of load and generation or can experience a step change due to the loss of a **Distribution Network** component which does not cause a loss of supply.
- 10.3.2 In order to ensure that such phenomena do not cause unnecessary tripping of **Micro-generators**, stability type tests shall be carried out.
- 10.3.3 The Rate of Change of Frequency (RoCoF) and Vector Shift values required for these tests are marginally less than the corresponding protection settings for RoCoF in Table 2 and vector shifts of up to  $50^\circ$ . Both stability tests shall be carried out in all cases.
- 10.3.4 The stability tests are to be carried out as per the table in Appendix 3 Form C of this document and the **Micro-generator** should remain connected during each and every test. The tests shall check that the **Micro-generator** remains stable and connected during the following scenarios:
- RoCoF:  $0.95 \text{ Hzs}^{-1}$  from 49.0 Hz to 51.0 Hz on both rising and falling frequency; and
  - Vector shift:  $50^\circ$  plus from 49.5 Hz and  $50^\circ$  minus from 50.5 Hz.

## 11 Quality of Supply

### 11.1 Harmonics and voltage fluctuation

11.1.1 The connection and operation of a **Micro-generator** in parallel with a **DNO's Distribution Network** shall not impair the quality of supply provided by the **DNO** to any **Customers**. In this respect the **Micro-generator** shall comply with:

- EN 61000-3-2 Class A for harmonics; and
- EN 61000-3-3 for voltage fluctuation and flicker with a  $d_{max}$  value of 4%.

**Micro-generators** are likely to be installed in large numbers on **LV Distribution Networks**. They are likely to operate for long periods with no diversity between them, and adjacent **Micro-generators** are likely to be of the same technology. Therefore, in order to accommodate a high number of **Micro-generators** on a **Distribution Network**, procedures are specified in Annex A1 and Annex A2, which need to be applied when testing for harmonics, voltage fluctuations, flicker and **DC** injection.

### 11.2 DC injection

11.2.1 The upper limit for **DC** injection is 0.25% of AC current rating per phase.

### 11.3 Electromagnetic Compatibility (EMC)

11.3.1 All equipment shall conform to the generic EMC standards: BS EN61000-6-3: Electromagnetic Compatibility, Generic Emission Standard; and BS EN61000-6-1: Electromagnetic Compatibility, Generic Immunity Standard.

### 11.4 Short Circuit Current Contribution

#### 11.4.1 Directly Coupled Micro-generators

The **Manufacturer** shall establish the maximum short circuit current contribution from the **Micro-generator** and the conditions under which this exists. This shall be determined in accordance with Annex A.2.3.4.

#### 11.4.2 Inverter Connected Micro-generators

**DNOs** need to understand the contribution that **Inverters** make to system fault levels in order to determine that they can continue to safely operate their **Distribution Networks** without exceeding design fault levels for switchgear and other circuit components.

As the output from an **Inverter** reduces to zero when a short circuit is applied to its terminals, a short circuit test does not represent the worst case scenario; in most cases the voltage will not collapse to zero for a **Distribution Network** fault.

To address this issue a test, which ensures that at least 10% of nominal voltage remains and which allows the **Micro-generator** to feed into a load with an X to R ratio of 2.5, is specified as detailed in Annex A1.3.5.

## Appendix 1 Emerging Technologies and other Exceptions

### Emerging Technologies

Ofgem published details of **Micro-generators** which are classified as emerging technologies in **Great Britain** in their document “Requirement for generators – ‘emerging technology’ decision document”, 17 May 2017. The list is reproduced in Table 4 below for reference.

**Table 4 – Emerging Technology Exceptions**

<b>Manufacturer</b>	<b>Micro-generator</b>
Baxi	‘Baxi Ecogen’ generators (the specific products are the Baxi Ecogen 24/1.0, Baxi Ecogen 24/1.0 LPG and Baxi Ecogen System).
KD Navien	KD Navien stirling engine m-CHP (Hybrigen SE) (the specific products are the ‘NCM-1130HH – 1 kWel’ and the ‘NCM-2030HH – 2 kWel’).
OkoFEN	Pellematic Smart_e
SenerTec	Dachs Stirling SE Erdgas and Dachs Stirling SE Flussiggas

For **Micro-generators** classified as an emerging technology at the time of their connection to a **DNO’s Distribution Network**, the following sections of EREC G98 do not apply.

- 9.1 (frequency withstand capability);
- 9.2 (rate of change of frequency);
- 9.3 (**Limited Frequency Sensitive Mode – Overfrequency**);
- 9.4 (constant **Active Power** output); and
- 10.1.3 (**Interface Protection** settings).

Performance requirements for these emerging technologies and other exemptions will conform to the voltage protection setting limits in Table 2 in Section 10.1 of this document, but they do not have to extend to the full ranges of the frequency protection requirements. For example, if a technology can only operate in a frequency range from 49.5 Hz to 50.5 Hz and outside of this it will disconnect from the **Distribution Network**, this technology would still be deemed to meet this EREC G98. Appropriate protection settings should be agreed with the **DNO**.

Emerging technology classification may be revoked as detailed in the Ofgem document “Requirement for generators – ‘emerging technology’ decision document”, 17 May 2017.

**Micro-generators** classified as emerging technologies and connected to the **Distribution Network** prior to the date of revocation of that classification as an emerging technology shall be considered to be existing generators, and this appendix continues to apply.

### Other Exceptions

For **Electricity Storage** devices commissioned before 01 September 2022 and **Micro-generating Plant**, including **Electricity Storage** devices, with a **Registered Capacity** of less than 800 W, the following sections of EREC G98 do not apply:

- 9.3 (Limited Frequency Sensitive Mode – Overfrequency); and

- 9.4.2 and 9.4.3 (constant **Active Power** output).

For the purpose of assessing the 800 W threshold, the **Registered Capacity** of the **Micro-generating Plant** should not include the capacity of **Electricity Storage** devices commissioned before 01 September 2022 where they are AC coupled with generation. However, where the **Electricity Storage** devices are **DC** coupled with generation, the **Registered Capacity** of the **Micro-generating Plant** is dictated by the **Inverter** rating, and this will determine whether the 800 W exception applies. Where **Electricity Storage** devices are **DC** coupled with generation with a **Registered Capacity** of or greater than 800 W, then the **Electricity Storage** exceptions do not apply to the **Inverter**.

## Appendix 2 Connection Procedure Flow Chart

The following flow charts are for installations with aggregate **Registered Capacities** of 16 A per phase or less. For an installation with aggregate **Registered Capacity** in excess of 16 A per phase refer to EREC G99.

NOTE: The processes shown here only refer to the interface between the **Installer** and the **DNO**. It may also be necessary for the **Installer / Customer** to inform the relevant **Meter Operator** and **Supplier** that a **Micro-generator** has been installed.

### Connecting Micro-generators in a single premises

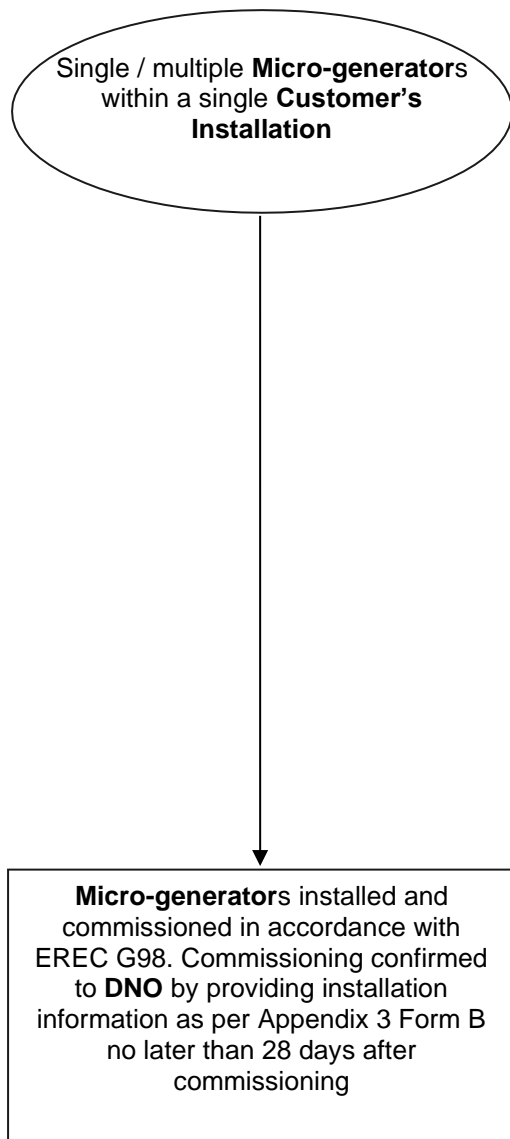

### Connecting Micro-generators in multiple premises

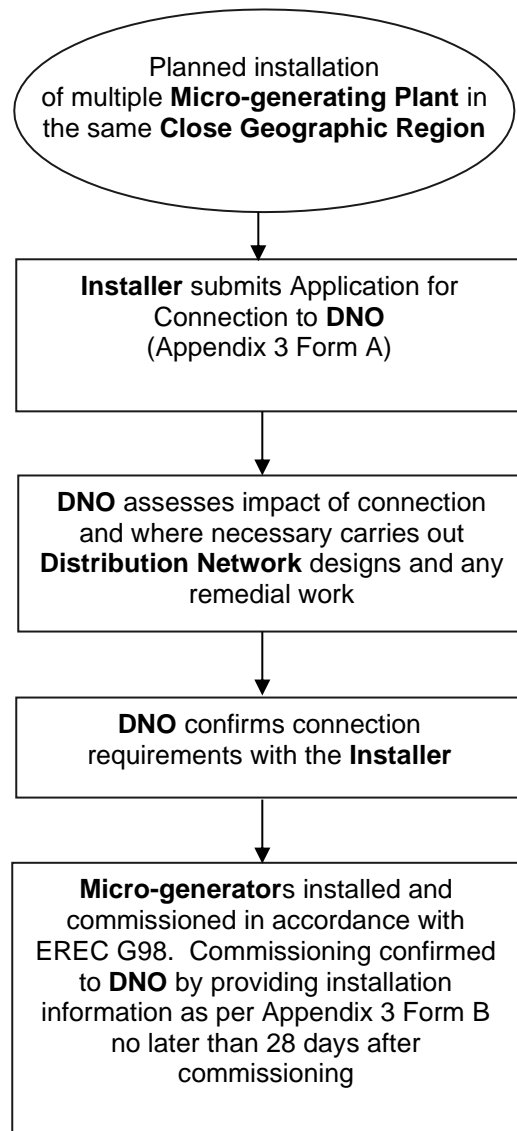

### Appendix 3. Micro-generator Documentation

A number of forms are required to be completed and submitted to the **DNO** for **Micro-generator** installations and any subsequent modifications to equipment, and/or permanent decommissioning. These are summarised in the table below. The stages in the table below are described in more detail in the Distributed Generation Connection Guides, which are available free of charge on the Energy Networks Association website<sup>7</sup>.

Stage	Form	Notes / Description	Single premises	Multiple premises	Complete Y/N
1. Find an <b>Installer</b>	N/A	No form required – see ENA Distributed Generation Connection Guides for more information. Outside of the scope of this document.	✓	✓	
2. Discuss with the <b>DNO</b>	N/A	As above.	x	✓	
3. Submit application	A: Application form	Submit an application, so that the <b>DNO</b> can assess whether there is a requirement for network studies and <b>Distribution Network</b> reinforcement.	x	✓	
4. Application acceptance	N/A	If the <b>DNO</b> determines that <b>Distribution Network</b> reinforcement is required to facilitate connecting your <b>Micro-generators</b> , they will make you a Connection Offer. Once you have accepted the <b>DNO's Connection Offer</b> , construction can begin.  See ENA Distributed Generation Connection Guides for more information.	x	✓	
5. Construction and commissioning	See below.	See ENA Distributed Generation Connection Guides for more information. See below (item 6) for relevant forms.	✓	✓	

<sup>7</sup> <https://www.energynetworks.org/industry-hub/resource-library/?search=generation%20&id=267>

6. Inform the <b>DNO</b>	<b>B: Installation Document</b>	Submit one form per premises, signed by the <b>Customer</b> and <b>Installer</b> .	✓	✓	
	<b>C: Type Test Verification Report</b>	To be provided, unless a <b>Manufacturer's</b> reference number registered with the ENA is available.	✓	✓	
7. Ongoing responsibilities	N/A	If a modification is made to the <b>Micro-generator</b> that affects its technical capabilities and compliance with this document a new <b>Type Test Verification Report</b> shall be provided.	✓	✓	
	D: Notification of decommissioning	Notify the <b>DNO</b> about the permanent decommissioning of a <b>Micro-generator</b> .	✓	✓	

The forms have been designed with the same format of **Customer** and **Installer** information at the top of each form. If you are completing forms electronically, this will allow you to copy and paste your information from one form to another, as you move through the stages of the connection process, unless you need to update your contact details.





Use continuation sheet where more than 10 **Micro-generators** are to be installed.

Please include an electronic map with the location of each Customer Installation highlighted in red.

Record **Micro-generator Registered Capacity** in kW at 230 V AC, to one decimal place, under PH1 for single phase supplies and under the relevant phase for two and three phase supplies. For example 2.8 kW.

Detail on a separate sheet if there are any proposals to limit export to a lower figure than that of the **Micro-generator**.

## Form B: Installation Document for connection under G98

Please complete and provide this document for each premises, once **Micro-generator** installation is complete.

To ABC electricity distribution **DNO**  
 99 West St, Imaginary Town, ZZ99 9AA abcd@wxyz.com

### Customer Details:

<b>Customer</b> (name)	
Address	
Post Code	
Contact person (if different from <b>Customer</b> )	
Telephone number	
E-mail address	
<b>Customer</b> signature	

### Installer Details:

<b>Installer</b>	
Accreditation / Qualification	
Address	
Post Code	
Contact person	
Telephone Number	
E-mail address	
<b>Installer</b> signature	

### Installation details

Address	
Post Code	
MPAN(s)	
Location within <b>Customer's Installation</b>	

Location of Lockable Isolation Switch								
<b>Details of Micro-generators.</b> Use a separate line for new and existing installations and for different technology type. Use PH 1 column for single phase supply.								
Manufacturer	Date of Installation	Energy source and energy conversion technology (enter codes from tables 1 and 2 below)	Manufacturer's Ref No (this number should be registered on the ENA Type Test Register as the system reference)	Micro-generator Registered Capacity in kW			Energy storage capacity for Electricity Storage devices (kWh)	
				3-Phase Units	Single Phase Units			
					PH1	PH2	PH3	
<b>Declaration – to be completed by Installer for Micro-generators Tested to EREC G98</b>								
I declare that the relevant <b>Micro-generators</b> and the installation which together form a <b>Micro-generating Plant</b> within the scope of EREC G98 at the above address, conform to the requirements of EREC G98. This declaration of compliance is confined to <b>Micro-generating Plant</b> tested to EREC G98 or EREC G83 as applicable at the time of commissioning.								
Signature:			Date:					

Table 1

	Energy Source
A	Advanced Fuel (produced via gasification or pyrolysis of biofuel or waste)
B	Biofuel - Biogas from anaerobic digestion (excluding landfill & sewage)
C	Biofuel - Landfill gas
D	Biofuel - Sewage gas
E	Biofuel - Other
F	Biomass
G	Fossil - Brown coal/lignite
H	Fossil - Coal gas
I	Fossil - Gas
J	Fossil - Hard coal

	Energy Source
K	Fossil - Oil
L	Fossil - Oil shale
M	Fossil - Peat
N	Fossil - Other
O	Geothermal
P	Hydrogen
Q	Nuclear
R	Solar
S	Stored Energy (all stored energy irrespective of the original energy source)
T	Waste
U	Water (flowing water or head of water)
V	Wind
W	Other

Table 2

	Energy Conversion Technology
1	Engine (combustion / reciprocating)
2	Fuel Cell
3	Gas turbine (OCGT)
4	Geothermal power plant
5	Hydro - Reservoir (not pumped)
6	Hydro - Run of river
7	Hydro - Other
8	Interconnector
9	Offshore wind turbines
10	Onshore wind turbines
11	Photovoltaic
12	Steam turbine (thermal power plant)
13	Steam-gas turbine (CCGT)
14	Tidal lagoons
15	Tidal stream devices
16	Wave devices
17	Storage - Chemical - Ammonia
18	Storage - Chemical - Hydrogen
19	Storage - Chemical - Synthetic Fuels

	Energy Conversion Technology
20	Storage - Chemical - Drop-in Fuels
21	Storage - Chemical - Methanol
22	Storage - Chemical - Synthetic Natural Gas
23	Storage - Electrical - Supercapacitors
24	Storage - Electrical - Superconducting Magnetic ES (SMES)
25	Storage - Mechanical - Adiabatic Compressed Air
26	Storage - Mechanical - Diabatic Compressed Air
27	Storage - Mechanical - Liquid Air Energy Storage
28	Storage - Mechanical - Pumped Hydro
29	Storage - Mechanical - Flywheels
30	Storage - Thermal - Latent Heat Storage
31	Storage - Thermal - Thermochemical Storage
32	Storage - Thermal - Sensible Heat Storage
33	Storage - Electrochemical Classic Batteries -Lead Acid
34	Storage - Electrochemical Classic Batteries -Lithium Polymer (Li-Polymer)
35	Storage - Electrochemical Classic Batteries -Metal Air
36	Storage - Electrochemical Classic Batteries -Nickle Cadmium (Ni-Cd)
37	Storage - Electrochemical Classic Batteries -Sodium Nickle Chloride (Na-NiCl <sub>2</sub> )
38	Storage - Electrochemical Classic Batteries -Lithium Ion (Li-ion)
39	Storage - Electrochemical Classic Batteries -Sodium Ion (Na-ion)
40	Storage - Electrochemical Classic Batteries -Lithium Sulphur (Li-S)
41	Storage - Electrochemical Classic Batteries -Sodium Sulphur (Na-S)
42	Storage - Electrochemical Classic Batteries -Nickle –Metal Hydride (Ni-MH)
43	Storage - Electrochemical Flow Batteries - Vanadium Red-Oxide
44	Storage - Electrochemical Flow Batteries - Zinc – Iron (Zn –Fe)
45	Storage - Electrochemical Flow Batteries - Zinc – Bromine (Zn –Br)
46	Storage - Other
47	Other

## Form C: Type Test Verification Report

All Micro-generators connected to the **DNO Distribution Network** shall be **Fully Type Tested**. This form is the **Manufacturer's** declaration of compliance with the requirements of EREC G98.

This form should be used when making a Type Test submission to the Energy Networks Association (ENA) Type Test Register.

If the **Micro-generator** is **Fully Type Tested** and already registered with the ENA Type Test Register, the **Installation Document** should include the **Manufacturer's** Reference Number (the system reference), and this form does not need to be submitted.

<b>Manufacturer's</b> reference number			
<b>Micro-generator</b> technology			
<b>Manufacturer</b> name			
Address			
Tel		Fax	
E-mail		Web site	
<b>Registered Capacity</b> , use separate sheet if more than one connection option.	Connection Option		
		kW single phase, single, split or three phase system	
		kW three phase	
		kW two phases in three phase system	
	kW two phases split phase system		
Energy storage capacity for <b>Electricity Storage</b> devices		kWh	
<b>Manufacturer Type Test</b> declaration. - I certify that all products supplied by the company with the above <b>Fully Type Tested</b> reference number will be manufactured and tested to ensure that they perform as stated in this document, prior to shipment to site and that no site modifications are required to ensure that the product meets all the requirements of EREC G98.			
Signed		On behalf of	

Note that testing can be done by the **Manufacturer** of an individual component or by an external test house.

Where parts of the testing are carried out by persons or organisations other than the **Manufacturer** then that person or organisation shall keep copies of all test records and results supplied to them to verify that the testing has been carried out by people with sufficient technical competency to carry out the tests.

**Operating Range:** This test should be carried out as specified in A.1.2.10.

Pass or failure of the test should be indicated in the fields below (right hand side), for example with the statement "Pass", "No disconnection occurs", etc. Graphical evidence is preferred.

<p>Test 1</p> <p>Voltage = 85% of nominal (195.5 V)</p> <p>Frequency = 47.0 Hz</p> <p>Power factor = 1</p> <p>Period of test 20 seconds</p>	<p>Test results or chart to confirm operation</p>
<p>Test 2</p> <p>Voltage = 85% of nominal (195.5 V)</p> <p>Frequency = 47.5 Hz</p> <p>Power factor = 1</p> <p>Period of test 90 minutes</p>	<p>Test results or chart to confirm operation</p>
<p>Test 3</p> <p>Voltage = 110% of nominal (253 V).</p> <p>Frequency = 51.5 Hz</p> <p>Power factor = 1</p> <p>Period of test 90 minutes</p>	<p>Test results or chart to confirm operation</p>
<p>Test 4</p> <p>Voltage = 110% of nominal (253 V).</p> <p>Frequency = 52.0 Hz</p> <p>Power factor = 1</p> <p>Period of test 15 minutes</p>	<p>Test results or chart to confirm operation</p>

<p>Test 5</p> <p>Voltage = 100% of nominal (230 V).</p> <p>Frequency = 50.0 Hz</p> <p>Power factor = 1</p> <p>Period of test 90 minutes</p>	<p>Test results or chart to confirm operation</p>
<p>Test 6 RoCoF withstand</p> <p>Confirm that the <b>Micro-Generating Plant</b> is capable of staying connected to the <b>Distribution Network</b> and operate at rates of change of frequency up to 1 Hzs<sup>-1</sup> as measured over a period of 500 ms.</p>	<p>Test results or chart to confirm operation</p>

**Power Quality – Harmonics:** These tests should be carried out as specified in BS EN 61000-3-2. The chosen test should be undertaken with a fixed source of energy at two power levels a) between 45 and 55% and b) at 100% of **Registered Capacity**. The test requirements are specified in Annex A1 A.1.3.1 (**Inverter** connected) or Annex A2 A.2.3.1 (Synchronous).

Micro-generator tested to BS EN 61000-3-2						
Micro-generator rating per phase (rpp)				kW		
For 3-phase <b>Micro-generators</b> , tick this box if harmonic measurements are identical for all three phases. If the harmonics are not identical for each phase, please replicate this section with the results for each phase.						
Harmonic	At 45-55% of <b>Registered Capacity</b> <sup>8</sup>		100% of <b>Registered Capacity</b>			
	Measured Value MV in Amps		M	e	Limit in BS EN 61000 -3-2 in Amps	Higher limit for odd harmonics 21 and above

<sup>8</sup> See the note in A.2.3.1 if 45-55% of **Registered Capacity** is below the minimum stable operating level. If an alternative loading level is chosen, the level should be indicated on the test form and the reason for not testing at 45-55% of **Registered Capacity** should be stated. The additional comments box at the end of the harmonics test sheet can be used for this.



			e M V i n A m p s			
2					1.080	
3					2.300	
4					0.430	
5					1.140	
6					0.300	
7					0.770	
8					0.230	
9					0.400	
10					0.184	
11					0.330	
12					0.153	
13					0.210	
14					0.131	
15					0.150	
16					0.115	
17					0.132	
18					0.102	
19					0.118	
20					0.092	
21					0.107	0.160
22					0.084	
23					0.098	0.147
24					0.077	
25					0.090	0.135

26					0.071	
27					0.083	0.124
28					0.066	
29					0.078	0.117
30					0.061	
31					0.073	0.109
32					0.058	
33					0.068	0.102
34					0.054	
35					0.064	0.096
36					0.051	
37					0.061	0.091
38					0.048	
39					0.058	0.087
40					0.046	

Note the higher limits for odd harmonics 21 and above are only allowable under certain conditions, if these higher limits are utilised please state the exemption used as detailed in part 6.2.3.4 of BS EN 61000-3-2 in the box below.

Additional comments:

**Power Quality – Voltage fluctuations and Flicker:** These tests should be undertaken in accordance with EREC G98 Annex A1 A.1.3.3 (**Inverter** connected) or Annex A2 A.2.3.3 (Synchronous).

The standard test impedance is 0.4  $\Omega$  for a single phase **Micro-generating Plant** (and for a two phase unit in a three phase system) and 0.24  $\Omega$  for a three phase **Micro-generating Plant** (and for a two phase unit in a split phase system). Please ensure that both test and standard impedance are completed on this form. If the test impedance (or the measured impedance) is different to the standard impedance, it must be normalised to the standard impedance as follows (where the **Power Factor** of the generation output is 0.98 or above):

d max normalised value = (Standard impedance / Measured impedance) x Measured value.

Where the **Power Factor** of the output is under 0.98 then the X to R ratio of the test impedance should be close to that of the standard impedance.

The stopping test should be a trip from full load operation.

The duration of these tests needs to comply with the particular requirements set out in the testing notes for the technology under test.

The test date and location must be declared.

Test start date				Test end date				
Test location								
	Starting			Stopping			Running	
	d(max)	d(c)	d(t)	d(max)	d(c)	d(t)	P <sub>st</sub>	P <sub>It</sub> 2 hours
Measured Values at test impedance								
Normalised to standard impedance								
Normalised to required maximum impedance								
Limits set under BS EN 61000-3-11	4%	3.3%	3.3%	4%	3.3%	3.3%	1.0	0.65
Test Impedance	R			Ω	X			Ω
Standard Impedance	R	0.24 * 0.4 ^		Ω	X	0.15 * 0.25 ^		Ω
Maximum Impedance	R			Ω	X			Ω

\*Applies to three phase and split single phase **Micro-generators**. Delete as appropriate.

^ Applies to single phase **Micro-generators** and **Micro-generators** using two phases on a three phase system. Delete as appropriate.

<p><b>Power quality – DC injection:</b> This test should be carried out in accordance with A 1.3.4 as applicable.</p> <p>The % DC injection (“as % of rated AC current” below) is calculated as follows:</p> <p>% DC injection = Recorded DC value in Amps / base current</p> <p>where the base current is the <b>Registered Capacity</b> (W) / 230 V. The % DC injection should not be greater than 0.25%.</p>				
Test power level	20%	50%	75%	100%
Recorded DC value in Amps				
as % of rated AC current				
Limit	0.25%	0.25%	0.25%	0.25%
<p><b>Power Quality – Power factor:</b> This test shall be carried out in accordance with A.1.3.2 and A.2.3.2 at three voltage levels and at <b>Registered Capacity</b> and the measured <b>Power Factor</b> must be greater than 0.95 to pass. Voltage to be maintained within ±1.5% of the stated level during the test.</p>				
	216.2 V	230 V	253 V	
Measured value				
<b>Power Factor</b> Limit	>0.95	>0.95	>0.95	

<p><b>Protection – Frequency tests:</b> These tests should be carried out in accordance with Annex A1 A.1.2.3 (<b>Inverter</b> connected) or Annex A2 A.2.2.3 (Synchronous). For trip tests, frequency and time delay should be stated. For “no trip tests”, “no trip” can be stated.</p>						
Function	Setting		Trip test		“No trip tests”	
	Frequency	Time delay	Frequency	Time delay	Frequency /time	Confirm no trip
U/F stage 1	47.5 Hz	20 s			47.7 Hz 30 s	
U/F stage 2	47 Hz	0.5 s			47.2 Hz 19.5 s	
					46.8 Hz 0.45 s	

O/F stage 1	52 Hz	0.5 s			51.8 Hz 120.0 s	
					52.2 Hz 0.45 s	

Note. For frequency trip tests the frequency required to trip is the setting  $\pm 0.1$  Hz. In order to measure the time delay a larger deviation than the minimum required to operate the protection can be used. The “No trip tests” need to be carried out at the setting  $\pm 0.2$  Hz and for the relevant times as shown in the table above to ensure that the protection will not trip in error.

**Protection – Voltage tests:** These tests should be carried out in accordance with Annex A1 A.1.2.2 (**Inverter** connected) or Annex A2 A.2.2.2 (Synchronous). For trip tests, voltage and time delay should be stated. For “no trip tests”, “no trip” can be stated.

Function	Setting		Trip test		“No trip tests”	
	Voltage	Time delay	Voltage	Time delay	Voltage /time	Confirm no trip
U/V	184 V	2.5 s			188 V 5.0 s	
					180 V 2.45 s	
O/V stage 1	262.2 V	1.0 s			258.2 V 5.0 s	
O/V stage 2	273.7 V	0.5 s			269.7 V 0.95 s	
					277.7 V 0.45 s	

Note for Voltage tests the Voltage required to trip is the setting  $\pm 3.45$  V. The time delay can be measured at a larger deviation than the minimum required to operate the protection. The No trip tests need to be carried out at the setting  $\pm 4$  V and for the relevant times as shown in the table above to ensure that the protection will not trip in error.

**Protection – Loss of Mains test:** For PV **Inverters** shall be tested in accordance with BS EN 62116. Other **Micro-generators** should be tested in accordance with A.2.2.4 at 10%, 55% and 100% of rated power.

To be carried out at three output power levels with a tolerance of plus or minus 5% in Test Power levels.<sup>9</sup>

Test Power	10%	55%	100%	10%	55%	100%
Balancing load on islanded network	95% of <b>Registered Capacity</b>	95% of <b>Registered Capacity</b>	95% of <b>Registered Capacity</b>	105% of <b>Registered Capacity</b>	105% of <b>Registered Capacity</b>	105% of <b>Registered Capacity</b>
Trip time. Limit is 0.5 s						

<sup>9</sup> See the note in A.2.2.4 if the suggested loading levels are below the minimum stable operating level. If alternative loading levels are chosen, the level should be indicated on the test form and the reason for not testing at 10%/55% of **Registered Capacity** should be stated. The additional comments box at the end of the loss of mains test sheet can be used for this.

For Multi phase **Micro-generators** confirm that the device shuts down correctly after the removal of a single fuse as well as operation of all phases.

Test Power	10%	55%	100%	10%	55%	100%
Balancing load on islanded network	95% of <b>Registered Capacity</b>	95% of <b>Registered Capacity</b>	95% of <b>Registered Capacity</b>	105% of <b>Registered Capacity</b>	105% of <b>Registered Capacity</b>	105% of <b>Registered Capacity</b>
Trip time. Ph1 fuse removed						
Test Power	10%	55%	100%	10%	55%	100%
Balancing load on islanded network	95% of <b>Registered Capacity</b>	95% of <b>Registered Capacity</b>	95% of <b>Registered Capacity</b>	105% of <b>Registered Capacity</b>	105% of <b>Registered Capacity</b>	105% of <b>Registered Capacity</b>
Trip time. Ph2 fuse removed						
Test Power	10%	55%	100%	10%	55%	100%
Balancing load on islanded network	95% of <b>Registered Capacity</b>	95% of <b>Registered Capacity</b>	95% of <b>Registered Capacity</b>	105% of <b>Registered Capacity</b>	105% of <b>Registered Capacity</b>	105% of <b>Registered Capacity</b>
Trip time. Ph3 fuse removed						

Note for technologies which have a substantial shut down time this can be added to the 0.5 s in establishing that the trip occurred in less than 0.5 s. Maximum shut down time could therefore be up to 1.0 s for these technologies.

Indicate additional shut down time included in above results.	ms
---------------------------------------------------------------	----

Additional comments:

For **Inverters** tested to BS EN 62116 the following sub set of tests should be recorded in the following table.

Test Power and imbalance	33%	66%	100%	33%	66%	100%
	-5% Q	-5% Q	-5% P	+5% Q	+5% Q	+5% P
	Test 22	Test 12	Test 5	Test 31	Test 21	Test 10

Trip time. Limit is 0.5 s <sup>10</sup>					
<b>Protection – Frequency change, Vector Shift Stability test:</b> This test should be carried out in accordance with EREC G98 Annex A1 A.1.2.6 ( <b>Inverter</b> connected) or Annex A2 A.2.2.6 (Synchronous). Confirmation is required that the <b>Micro-generating Plant</b> does not trip under positive / negative vector shift.					
	Start Frequency	Change	Confirm no trip		
Positive Vector Shift	49.0 Hz	+50 degrees			
Negative Vector Shift	50.0 Hz	- 50 degrees			
<b>Protection – Frequency change, RoCoF Stability test:</b> The requirement is specified in section 11.3, test procedure in Annex A.1.2.6 ( <b>Inverter</b> connected) or Annex A2 A.2.2.6 (Synchronous). Confirmation is required that the <b>Micro-generating Plant</b> does not trip for the duration of the ramp up and ramp down test.					
Ramp range	Test frequency ramp:	Test Duration	Confirm no trip		
49.0 Hz to 51.0 Hz	+0.95 Hzs <sup>-1</sup>	2.1 s			
51.0 Hz to 49.0 Hz	-0.95 Hzs <sup>-1</sup>	2.1 s			
<b>Limited Frequency Sensitive Mode – Overfrequency test:</b> This test should be carried out in accordance with A.1.2.8. The test should be carried out using the specific threshold frequency of 50.4 Hz and <b>Droop</b> of 10%. The measurement tolerances are contained in A.1.2.8.					
Test sequence at <b>Registered Capacity</b> >80%	Measured <b>Active Power</b> Output	Frequency	Primary Power Source	<b>Active Power Gradient</b>	
Step a) 50.00 Hz ±0.01 Hz				-	
Step b) 50.45 Hz ±0.05 Hz				-	
Step c) 50.70 Hz ±0.10 Hz				-	
Step d) 51.15 Hz ±0.05 Hz				-	
Step e) 50.70 Hz ±0.10 Hz				-	
Step f) 50.45 Hz ±0.05 Hz				-	
Step g) 50.00 Hz ±0.01 Hz					
Test sequence at <b>Registered Capacity</b> 40% - 60%	Measured <b>Active Power</b> Output	Frequency	Primary Power Source	<b>Active Power Gradient</b>	
Step a) 50.00 Hz ±0.01 Hz				-	

<sup>10</sup> If the device requires additional shut down time (beyond 0.5 s but less than 1 s) then this should be stated on this form.

Step b) 50.45 Hz $\pm$ 0.05 Hz				-	
Step c) 50.70 Hz $\pm$ 0.10 Hz				-	
Step d) 51.15 Hz $\pm$ 0.05 Hz				-	
Step e) 50.70 Hz $\pm$ 0.10 Hz				-	
Step f) 50.45 Hz $\pm$ 0.05 Hz				-	
Step g) 50.00 Hz $\pm$ 0.01 Hz					
<b>Power output with falling frequency test:</b> This test should be carried out in accordance with A.1.2.7.					
Test sequence	Measured <b>Active Power Output</b>	Frequency	Primary power source		
Test a) 50 Hz $\pm$ 0.01 Hz					
Test b) Point between 49.5 Hz and 49.6 Hz					
Test c) Point between 47.5 Hz and 47.6 Hz					
NOTE: The operating point in Test (b) and (c) shall be maintained for at least 5 minutes					
<b>Re-connection timer.</b>					
Test should prove that the reconnection sequence starts after a minimum delay of 20 s for restoration of voltage and frequency to within the stage 1 settings of Table 2. Both the time delay setting and the measured delay should be provided in this form; both should be greater than 20 s to pass. Confirmation should be provided that the <b>Micro-generating Plant</b> does not reconnect at the voltage and frequency settings below; a statement of "no reconnection" can be made.					
Time delay setting	Measured delay		Checks on no reconnection when voltage or frequency is brought to just outside stage 1 limits of table 2.		
			At 266.2 V	At 180.0 V	
			At 47.4 Hz	At 52.1 Hz	
Confirmation that the <b>Micro-generator</b> does not re-connect.					
<b>Fault level contribution:</b> These tests shall be carried out in accordance with EREC G98 Annex A1 A.1.3.5 ( <b>Inverter</b> connected) and Annex A2 A.2.3.4 (Synchronous). Please complete each entry, even if the fault contribution is zero.					
For machines with electro-magnetic output			For <b>Inverter</b> output		
Parameter	Symbol	Value	Time after fault	Volts	Amps
Peak Short Circuit current	$i_p$		20 ms		
Initial Value of aperiodic current	$A$		100 ms		



Initial symmetrical short-circuit current*	$I_k$		250 ms		
Decaying (aperiodic) component of short circuit current*	$i_{DC}$		500 ms		
Reactance/Resistance Ratio of source*	$X/R$		Time to trip		In seconds
<p>For rotating machines and linear piston machines the test should produce a 0 s – 2 s plot of the short circuit current as seen at the <b>Micro-generator</b> terminals.</p> <p>* Values for these parameters should be provided where the short circuit duration is sufficiently long to enable interpolation of the plot</p>					
<b>Logic Interface (input port)</b>					
Confirm that an input port is provided and can be used to reduce the <b>Active Power</b> output to zero					Yes / NA
Provide high level description of logic interface, e.g. details in 9.4.3 such as AC or <b>DC</b> signal (the additional comments box below can be used)					Yes / NA
<b>Self-Monitoring solid state switching:</b> No specified test requirements. Refer to EREC G98 Annex A1 A.1.3.6 ( <b>Inverter</b> connected).					Yes / NA
It has been verified that in the event of the solid state switching device failing to disconnect the <b>Micro-generator</b> , the voltage on the output side of the switching device is reduced to a value below 50 V within 0.5 s.					
<b>Cyber security</b>					
Confirm that the <b>Manufacturer</b> or <b>Installer</b> of the <b>Micro-generator</b> has provided a statement describing how the <b>Micro-generator</b> has been designed to comply with cyber security requirements, as detailed in 9.7.					Yes / NA
Additional comments					

## Form D: Micro-generator Decommissioning Confirmation

**Micro-generator** de-commissioning form and declaration, to be provided to the **DNO** by the **Installer** no later than 28 days after de-commissioning all, or some of the **Micro-generators** in a **Customer's Installation**.

To ABC electricity distribution DNO  
99 West St, Imaginary Town, ZZ99 9AA abced@wxyz.com

### Customer Details:

**Customer** (name)

Address

Post Code

Contact person (if different from **Customer**)

Telephone number

E-mail address

MPAN(s)

### Installer Details:

**Installer**

Accreditation / Qualification

Address

Post Code

Contact person

Telephone Number

E-mail address

### Installation details:

Address

Post Code

MPAN(s)

Details of removed <b>Micro-generator(s)</b>					
Manufacturer and model type	Fully Type Tested Reference number or <b>Manufacturer's</b> reference number	Prime mover and fuel source	Registered Capacity in kW		
			Phase 1	Phase 2	Phase 3
Details of remaining <b>Micro-generator(s)</b>					
Manufacturer and model type	Fully Type Tested Reference number or <b>Manufacturer's</b> reference number	Prime mover and fuel source	Registered Capacity in kW		
			Phase 1	Phase 2	Phase 3
I confirm that the <b>Micro-generator</b> installation noted above has totally de-commissioned and that any remaining <b>Micro-generating Plant</b> continues to conform to the requirements of EREC G83 or EREC G98 as appropriate, as required by the Distribution Code of <b>Great Britain</b> . I enclose a copy of the system schematic which has been left on site at the <b>Customer's</b> incoming meter location.					
Installer Name		Signed		Date	

## **Appendix 4 Relaxation of Commissioning Notification Timescales for Micro-generator: HSE Certificate of Exemption (August 2008)**

Electricity Act 1989

Health & Safety At Work Etc Act 1974

The **Electricity Safety Quality and Continuity Regulations 2002**

Certificate of Exemption

The Health and Safety Executive, in pursuance of the powers conferred on it by section 33 of the **Electricity Safety Quality and Continuity Regulations 2002** (the "Regulations") Health & Safety At Work Etc Act 1974 ( as amended by the Legislative Reform ( Health and Safety Executive) Order 2008) and by the Agreement dated 2 October 2006 between the Secretary of State for Trade and Industry and the Health and Safety Commission, and being satisfied as required by regulation 33(2) hereby grants an exemption to the person or persons installing the source of energy from the requirements imposed by regulation 22(2)(c) of the regulations subject to the condition set out in paragraph 2 of this certificate.

The condition referred to in paragraph 1 of this certificate is that in so far as Regulation 22(2) (c) of the regulations applies to a source of energy, the person or persons installing the source of energy will ensure that the distributor is advised of the intention to use the source of energy in parallel with network no later than 28 days (inclusive of the day of commissioning) after commissioning the source.

This certificate shall come into force on 4 August 2008 and will remain in force until revoked by the Health and Safety Executive by a certificate in writing.

## A.1 Annex A1 Requirements for Type Testing of Inverter Connected Micro-generators

### A.1.1 General

This Annex describes a methodology for obtaining type certification or type verification for **Micro-generators** which are connected to the **Distribution Network** via an **Inverter**.

Typically, all interface functions are contained within an **Inverter** and in such cases it is only necessary to have the **Inverter Fully Type Tested**. In the case where a package of specific separate parts are used to assemble a **Fully Type Tested Micro-generator** the completed **Micro-generator's Interface Protection** shall not rely on interconnection using cables which could be terminated incorrectly on site ie the interconnections shall be made by plug and socket which the **Manufacturer** has made and tested prior to delivery to site.

The **Interface Protection** shall satisfy the requirements of all of the following standards. Where these standards have more than one part, the requirements of all such parts shall be satisfied, so far as they are applicable.

BS EN 61000 (Electromagnetic Standards)

BS EN 60255 (Electrical Relays)

BS EN 61810 (Electrical Elementary Relays)

BS EN 60947 (Low Voltage Switchgear and Control gear)

BS EN 61869 (Instrument Transformers: Additional requirements for current transformers)

Currently there are no harmonised functional standards that apply to the **Microgenerator's Interface Protection**. Consequently, in cases where power electronics is used for energy conversion along with any separate **Interface Protection** unit they will need to be brought together and tested as a complete **Microgenerator** as described in this EREC G98, and recorded in a format similar to that shown in Form C (Appendix 3).

Where the **Interface Protection** is physically integrated within the overall **Micro-generator** control system, the functionality of the **Interface Protection** unit should not be compromised by any failure of other elements of the control system (fail safe).

This Annex applies to **Micro-generators**:

- with or without or energy storage systems connected on the energy source or prime mover side of the **Micro-generator**; and
- with or without load management devices.

### A.1.2 Type Verification Functional Testing of the Interface Protection

Type testing is the responsibility of the **Manufacturer**.

The type testing can be done by the **Manufacturer** of an individual component or by an external test house or by the supplier of the complete system, or any combination of them as appropriate.

The type testing will verify that the operation of the **Interface Protection** shall result:

- a) in the safe disconnection of the **Micro-generator** from the **DNO's Distribution Network** in the event that the protection settings specified in Table 2 are exceeded; and

- b) in the **Micro-generator** remaining connected to the **DNO's Distribution Network** while **Distribution Network** conditions are:
- 1) within the envelope specified by the settings plus and minus the tolerances specified for equipment operation in Table 2; and
  - 2) within the time delay settings specified in Table 2.

Wherever possible the type testing of a **Micro-generator** designed for a particular type of prime mover should be proved under normal conditions of operation for that technology (unless otherwise noted).

#### **A 1.2.1 Disconnection times**

The minimum trip time delay settings, for over / under voltage, over / under frequency and loss of mains tests below, are presented in Table 2.

For over / under voltage, over / under frequency and loss of mains tests, reconnection shall be checked as detailed below.

#### **A 1.2.2 Over / Under Voltage**

The **Micro-generator** shall be tested by operating the **Micro-generator** in parallel with a variable AC test supply, as an example see Figure A1.1. Correct protection and ride-through operation shall be confirmed. The set points for over and under voltage at which the **Micro-generator** disconnects from the supply will be established by varying the AC supply voltage. The disconnect sequence should be initiated when the network conditions mean the protection should trip in accordance with the settings in Table 2, otherwise normal operation should continue.

To establish the certified trip voltage, the test voltage should be applied in steps of  $\pm 0.5\%$  of setting for a duration that is longer than the trip time delay, for example 1 s in the case of a delay setting of 0.5 s. It will be necessary to carry out five tests for each trip setting. The test voltage at which this trip occurred is to be recorded as the certified trip voltage.

To establish the certified trip time, the test voltage should be applied starting from  $\pm 1.8\%$  below the certified trip voltage in a step of at least  $\pm 0.5\%$  of setting for a duration that is longer than the trip time delay, for example 1 s in the case of a delay setting of 0.5 s. Where the **Interface Protection** functionality is implemented in the **Micro-generator** it will be necessary to carry out five tests for each trip setting. The longest trip time is to be recorded as the certified trip time.

For example to test overvoltage setting stage 1 which is required to be set at nominally 262.2 V the circuit can be set up as shown below and the voltage adjusted to 254.2 V. In integrated designs where there is no separate way of establishing that the **Micro-generator** is disconnected, the **Micro-generator** should be powered up to export a measurable amount of energy so that it can be confirmed that the **Micro-generator** has ceased to output energy. The variable voltage supply is then increased in steps of no more than 0.5% of nominal (1.15 V) maintaining the voltage for at least 1.5 s (trip time plus 0.5 s) at each voltage level. At each voltage level confirmation that the **Micro-generator** has not tripped after the time delay is required to be taken. At the voltage level at which a trip occurs then this should be recorded as the provisional trip voltage. Additional tests just below and if necessary just above the provisional trip voltage will allow the actual trip voltage to be established on a repeatable basis. This value should be recorded. For the sake of this example the actual trip level is assumed to have been established as being 261 V. The variable voltage supply should be

set to 257 V, the **Micro-generator** set to produce a measurable output (if necessary) and then the voltage raised to 265 V in a single step. The time from the step change to the disconnection of the **Micro-generator** should be recorded as the trip time.

The **Micro-generator** then needs to operate at 4 V below the nominal overvoltage stage 1 setting which is 258.2 V for a period of at least 2 s without tripping and while producing a measurable output. This can be confirmed as a no trip in the relevant part of the **Type Test Verification Report**, Appendix 3 Form C. The voltage then needs to be stepped up to the next level of 269.7 V for a period of 0.98 s and then back to 258.2 V during which time the output of the relay should continue with no interruption though it may change due to the change in voltage, this can be recorded as a no trip for the second value. The step up and step down test needs to be done a second time with a max value of 277.7 V and with a time of 0.48 s. The **Micro-generator** is allowed to shut down during this period to protect itself as allowed by footnote 3 of Table 2 of this document, but it shall resume production again when the voltage has been restored to 258.2 V or it may continue to produce an output during this period. There is no defined time for resumption of production but it shall be shown that the **Micro-generator** restart timer has not operated so it begins producing again in less than 20 s.

Note that this philosophy should be applied to the under voltage, over and under frequency, RoCoF and Vector shift stability tests which follow.

Note:

- (1) The frequency required to trip is the setting  $\pm 0.1$  Hz
- (2) Measurement of operating time should be measured at a value of 0.3 Hz (suggestion – 2 x tolerance) above/below the setting to give “positive” operation
- (3) The “No trip tests” need to be carried out at the relevant values and times as shown in the **Type Test Verification Report**, Appendix 3 Form C to ensure that the protection will not trip in error.

**Figure A1.1 Micro-generator test set up – over / under Voltage**

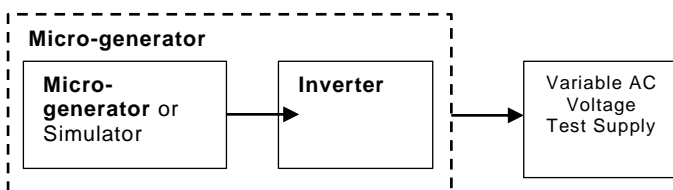

### **A 1.2.3 Over / Under Frequency**

The **Micro-generator** shall be tested by operating in parallel with a low impedance, variable frequency test supply system, see Figure A1.2. Correct protection and ride-through operation should be confirmed during operation of the **Micro-generator**. The set points for over and under frequency at which the **Micro-generator** disconnects from the supply will be established by varying the test supply frequency.

To establish a trip frequency, the test frequency should be applied in a slow ramp rate of less than  $0.1 \text{ Hz s}^{-1}$ , or if this is not possible in steps of 0.05 Hz for a duration that is longer than the trip time delay, for example 1 s in the case of a delay setting of 0.5 s. The test frequency at which this trip occurred is to be recorded. Additional tests just above and below the trip frequency should be undertaken to show that the test is repeatable and the figure at which a

repeatable trip occurs should be recorded on the **Type Test Verification Report**, Appendix 3 Form C.

To establish the trip time, the test frequency should be applied starting from 0.3 Hz below or above the recorded trip frequency and should be changed to 0.3 Hz above or below the recorded trip frequency in a single step. The time taken from the step change to the **Micro-generator** tripping is to be recorded on the **Type Test Verification Report**, Appendix 3 Form C. It should be noted that with some loss of mains detection techniques this test may result in a faster trip due to operation of the loss of mains protection. To avoid this it is necessary to establish an accurate frequency for the trip to enable the use of a much smaller step change to initiate the trip and establish a trip time. This may require the test to be repeated several times to establish that the time delay is correct.

To establish correct ride-through operation, the test frequency should be applied at each setting  $\pm 0.2$  Hz and for the relevant times shown in the **Type Test Verification Report**, Appendix 3 Form C.

**Figure A1.2 test set up – over / under Frequency**

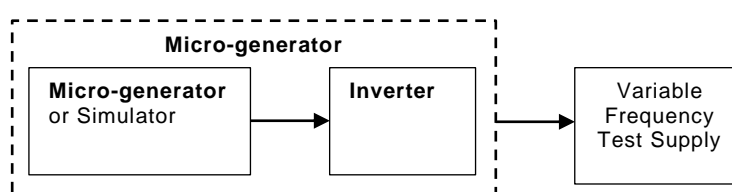

#### **A 1.2.4 Loss of Mains Protection**

The tests should be carried out in accordance with BS EN 62116 and a subset of results should be recorded as indicated in the Protection – Loss of Mains test section of the **Type Test Verification Report**, Appendix 3 Form C.

#### **A 1.2.5 Reconnection**

Further tests will confirm that once the AC supply voltage and frequency have returned to be within the stage 1 settings specified in Table 2 following an automatic protection trip operation there is a minimum time delay of 20 s before the **Micro-generator** output is restored (ie before the **Micro-generator** automatically reconnects to the **Distribution Network**).

#### **A 1.2.6 Frequency Drift and Step Change Stability test**

The tests will be carried out using the same circuit as specified in A1.2.3 above and following confirmation that the **Micro-generator** has passed the under and over frequency trip tests and the under and over frequency stability tests.

Four tests are required to be carried out with all protection functions enabled including loss of mains. For each stability test the **Micro-generator** should not trip during the test.

For the step change test the **Micro-generator** should be operated with a measurable output at the start frequency and then a vector shift should be applied by extending or reducing the time of a single cycle with subsequent cycles returning to the start frequency. The start frequency should then be maintained for a period of at least 10 s to complete the test. The **Micro-generator** should not trip during this test.



For frequency drift tests the **Micro-generator** should be operated with a measurable output at the start frequency and then the frequency changed in a ramp function at  $0.95 \text{ Hzs}^{-1}$  to the end frequency. On reaching the end frequency it should be maintained for a period of at least 10 s. The **Micro-generator** should not trip during this test.

The results shall be recorded on the **Type Test Verification Report**, Appendix 3 Form C.

#### **A 1.2.7 Active Power feed-in at under-frequency**

Tests shall be undertaken to verify the **Active Power** feed-in at under-frequency.

The tests for providing evidence of the frequency dependent active power feed-in of the **Micro-generator** shall be carried out on a network simulator.

Measurements shall be carried out at the following operating points:

- a)  $50 \text{ Hz} \pm 0.01 \text{ Hz}$ ;
- b) a point between 49.5 Hz and 49.6 Hz;
- c) a point between 47.5 Hz and 47.6 Hz.

The operating point b) and c) shall be maintained for at least 5 minutes.

The test is regarded as passed if:

- the **Micro-generator** does not disconnect from the network at the operating points a) to c) when the network frequency is changed and
- the **Micro-generator** does not reduce output energy at point b) and
- the power reduction at point c) is less than or equal to the allowed power reduction according to paragraph 9.4.2

The following data shall be documented:

- variation of the network frequency with time;
- the measured **Active Power** with time.

#### **A.1.2.8 Micro-generators which include Electricity Storage**

This paragraph provides a method for demonstrating compliance with the optional performance characteristic as discussed in the foreword. The **Manufacturer** shall demonstrate how the **Micro-generator Active Power** when acting as a load (ie replenishing its energy store) responds to changes in system frequency.

In general four tests are proposed, one set of two at rated import capacity, and one set of two at 40% of rated import capacity.

In both cases the test is to reduce frequency from 50 Hz at  $2 \text{ Hzs}^{-1}$ . In the first case the lower frequency reached will be 49.0 Hz and the second case the lower frequency will be 48.8 Hz.

In all cases the response shall meet the requirements of 9.4.3.

#### **A 1.2.9 Power response to over-frequency**

Tests shall be undertaken using the test set up in Figure A1.2 to verify the **Active Power** reduction to over-frequency using a specific standard frequency threshold of 50.4 Hz and a **Droop** of 10%. The test should be carried out above 80% **Registered Capacity** and repeated at 40-60% **Registered Capacity**.

The **Micro-generator** shall be at the following frequencies (refer to Figure A1.3):

- a) 50.00 Hz  $\pm$  0.01 Hz;
- b) 50.40+0.05 Hz  $\pm$  0.05 Hz;
- c) 50.70 Hz  $\pm$  0.10 Hz;
- d) 51.15 Hz  $\pm$  0.05 Hz;
- e) 50.70 Hz  $\pm$  0.10 Hz;
- f) 50.40+0.05 Hz  $\pm$  0.05 Hz;
- g) 50.00 Hz  $\pm$  0.01 Hz.

The frequency at each step should be maintained for at least one minute and the **Active Power** reduction in the form of a gradient determined and assessed for compliance with paragraph 9.4.

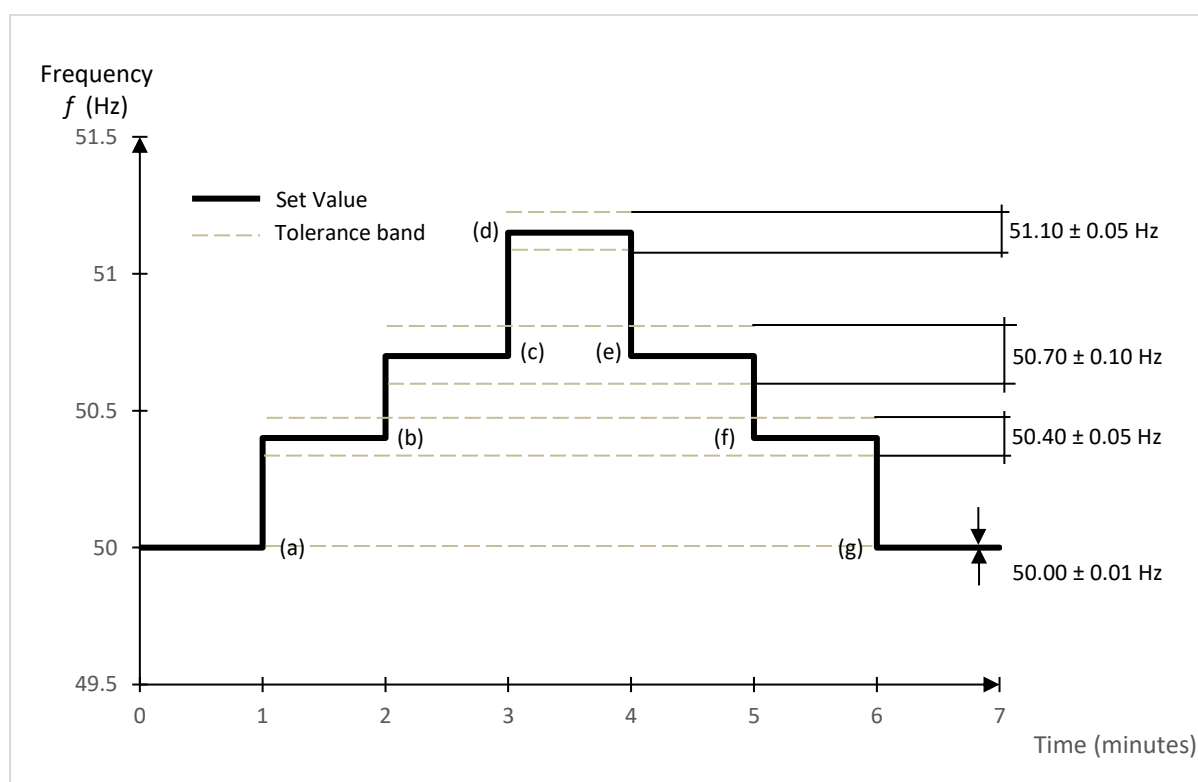

Figure A1.3 Testing the **Active Power** feed-in of the **Micro-generator** at over frequency.

The **Droop** should be determined from the measurements between 50.4 Hz and 51.15 Hz. The allowed tolerance for the frequency measurement shall be  $\pm$  0.05 Hz. The allowed tolerance for **Active Power** output measurement shall be  $\pm$ 10% of the required change in **Active Power**. The resulting overall tolerance range for a nominal 10% **Droop** is +2.8% and - 1.5%, ie a **Droop** less than 12.8% and greater than 8.5%.

#### A.1.2.10 Operating Range

Six tests shall be conducted with the Micro-generator operating at **Registered Capacity** connected to a grid simulator set as follows:

- Test 1, Voltage = 85% of nominal, frequency = 47 Hz, Power factor = 1, Period of test 20 s.
- Test 2, Voltage = 85% of nominal, frequency = 47.5 Hz, Power factor = 1, Period of

test 90 minutes.

- Test 3, Voltage = 110% of nominal, frequency = 51.5 Hz, Power factor = 1, Period of test 90 minutes.
- Test 4, Voltage = 110% of nominal, frequency = 52.0 Hz, Power factor = 1, Period of test 15 minutes.
- Test 5, Voltage = 100% of nominal, frequency = 50.0 Hz, Power factor = 1, Period of test 90 minutes.
- Test 6, Confirm that the **Micro-Generating Plant** is capable of staying connected to the **Distribution Network** and operate at rates of change of frequency up to 1 Hzs<sup>-1</sup> as measured over a period of 500 ms.

The **Interface Protection** shall be disabled during the tests.

Automatic adjustment to reduce power in the case of over frequency shall be disabled for Tests 3 and 4.

**Active Power** shall be recorded every second. The tests will verify that the **Micro-generator** can operate within the required ranges for the specified period of time.

In case of a PV **Micro-generator** the PV primary source may be replaced by a **DC** source.

In case of a full converter **Micro-generator** (eg wind) the primary source and the prime mover **Inverter**/rectifier may be replaced by a **DC** source.

In case of a DFIG **Micro-generator** the mechanical drive system may be replaced by a test bench motor.

### A.1.3 POWER QUALITY

#### A 1.3.1 Harmonics

The tests should be carried out as specified in BS EN 61000-3-2 and can be undertaken with a fixed source of energy at two power levels firstly between 45 and 55% and at 100% of **Registered Capacity**.

The test shall be carried out with a minimum of 2 kW of rated **Micro-generators**. Where an individual **Micro-generator** is smaller than 2 kW it should be tested as a group. However, where a **Micro-generator** is designed to be installed singly in an installation then this can be tested alone, for example a domestic CHP unit. The maximum group size for the test is 3.68 kW.

The results for all **Micro-generators** should be normalised to a rating of 3.68 kW. The **Micro-generator** or group shall meet the harmonic emissions of Table 1 in BS EN 61000-3-2 with a scaling factor applied as follows for each harmonic current:

BS EN 61000-3-2 Table 1 current limit  $\times$  rating of **Micro-generator** being tested (kW) per phase / 3.68

#### A 1.3.2 Power Factor

The test set up shall be such that the **Inverter** supplies full load to the **DNO's Distribution Network** via the power factor (pf) meter and the variac as shown below in Figure A1.4. The **Inverter** pf should be within the limits given in paragraph 9.6 for three test voltages 230 V – 6%, 230 V and 230 V +10%. The voltage shall be maintained within  $\pm 1.5\%$  of the stated level

during the test.

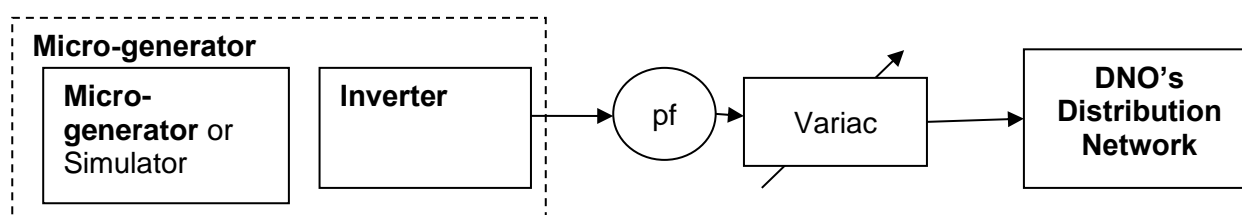

NOTE 1. For reasons of clarity the points of isolation are not shown

NOTE 2: It is permissible to use a voltage regulator or tapped transformer to perform this test rather than a variac as shown

**Figure A1.4 test set up – Power Factor**

### A 1.3.3 Voltage Flicker

The test shall be carried out with a minimum of 2 kW of rated **Micro-generators**. Where an individual **Micro-generator** is smaller than 2 kW it should be tested as a group. However, where a **Micro-generator** is designed to be installed singly in an installation then this can be tested alone, for example a domestic CHP unit. The maximum group size for the test is 3.68 kW.

The **Micro-generator** or group shall meet the required  $d_{max}$ ,  $d_c$ ,  $d_{(t)}$ ,  $P_{st}$ ,  $P_{lt}$  requirements of BS EN 61000-3-3 with a scaling factor applied as follows for each voltage change component.

$$d_{max}, d_c, d_{(t)}, P_{st}, P_{lt} \times \text{rating of Micro-generator being tested (kW) per phase} / 3.68$$

The results for groups of **Micro-generators** should be normalised to a rating of 3.68 kW and to the standard source impedance. Single **Micro-generators** need to be normalised to the standard source impedance, these normalised results need to conform to the limits set out in the **Type Test Verification Report**, Appendix 3 Form C.

For voltage change and flicker measurements the following simplified formula is to be used to convert the measured values to the normalised values where the power factor of the **Micro-generator** output is 0.98 or above. Where it is less than 0.98 then compliance with the full requirements of BS EN 61000-3-3 is required.

Normalised value = Measured value  $\times$  reference source resistance/measured source resistance at test point.

And for units which are tested as a group.

Normalised value = Measured value  $\times$  reference source resistance/measured source resistance at test point  $\times$  3.68/rating per phase.

Single phase units reference source resistance is 0.4  $\Omega$ .

Two phase units in a three phase system reference source resistance is 0.4  $\Omega$ .

Two phase units in a split phase system reference source resistance is 0.24  $\Omega$ .

Three phase units reference source resistance is 0.24  $\Omega$ .

The stopping test should be a trip from full load output.

The dates and location of the tests need to be noted in the **Type Test Verification Report**, Appendix 3 Form C.

Note: For wind turbines, flicker testing should be carried out during the performance tests specified in IEC 61400-12-1. Flicker data should be recorded from wind speeds of  $1 \text{ ms}^{-1}$  below cut-in to 1.5 times 85% of the rated power. The wind speed range should be divided into contiguous bins of 1 m/s centred on multiples of  $1 \text{ ms}^{-1}$ . The dataset shall be considered complete when each bin includes a minimum of 10 mins of sampled data. The highest value of each parameter measured across the entire range of tests shall be recorded.

Note: As an alternative to type testing the **Manufacturer** of a **Micro-generator** incorporating an **Inverter** may give a guarantee that rates of change of output do not exceed the following ramp rate limits. Output needs to ramp up at a constant rate.

This exception to site testing does not apply to devices where the output changes in steps of over 30 ms rather than as a ramp function, a site test is required for these units.

- Single phase units and two phase units in a three phase system, maximum ramp up rate  $333 \text{ W s}^{-1}$ ;
- Two phase units in a split phase system and three phase units, maximum ramp up rate  $860 \text{ W s}^{-1}$ .

It should be noted that units conforming to this declaration are likely to be less efficient at capturing energy during times when the energy source is changing.

For technologies other than wind turbines, testing should ensure that the controls or automatic programs used produce the most unfavourable sequence of voltage changes.

**Hydro Micro-generators** where the output is controlled by varying the load on the generator using the **Inverter** and which therefore produce variable output need to conform to the maximum voltage change requirements of BS EN 61000-3-2 and also need to be tested for  $P_{st}$  and  $P_{it}$  over a period where the range of flows varies over the design range of the turbine with a period of at least 2 hours at each step with there being 10 steps from min flow to maximum flow.  $P_{st}$  and  $P_{it}$  values to recorded and normalised as per the method laid down in the **Type Test Verification Report**, Appendix 3 Form C.

#### A 1.3.4 DC Injection for Inverters

Where a **Micro-generator** is designed to be installed singly in an installation, for example a domestic CHP unit, then this **DC** injection limit can be a maximum value of 20 mA for sub 2 kW **Micro-generator** and can be tested alone. Where **Micro-generators** are designed such that multiple units may be installed in an installation for example roof mounted wind turbines and PV with micro **Inverters** on each panel, then they should be tested as a group of at least 2 kW and with a maximum group size of 4 kW.

The level of **DC** injection from the **Inverter**-connected **Micro-generator** into the **DNO's Distribution Network** shall not exceed the levels specified in Section 11 when measured during operation at three levels, 10%, 55% and 100% of **Registered Capacity** with a tolerance of plus or minus 5%.

The **DC** component can be measured by one of the following two methods:

- the average of the current samples (preferred);
- root mean square of frequencies components below 1 Hz.

The **DC** component level shall be measured with an observation period large enough to ensure repeatability, and of at least 60 s.

As an example, at 230 V a 2 kW single phase **Inverter** has a current output of 8.7 A so **DC** limit is 21.75 mA; a 10 kW three phase **Inverter** has a current output of 14.5 A per phase which is equivalent to a total of 43.5 A at 230 V so **DC** limit is 108.75 mA.

### A 1.3.5 Short Circuit Current Contribution for Inverters

**Inverter** connected **Micro-generators** generally have small short circuit fault contributions, however, **DNOs** need to understand the contribution that they make to system fault levels in order to determine that they can continue to safely operate without exceeding design fault levels for switchgear and other circuit components.

The following type tests shall be carried out and the results noted in the **Type Test Verification Report**, Appendix 3 Form C.

Figure A1.5 Test circuit

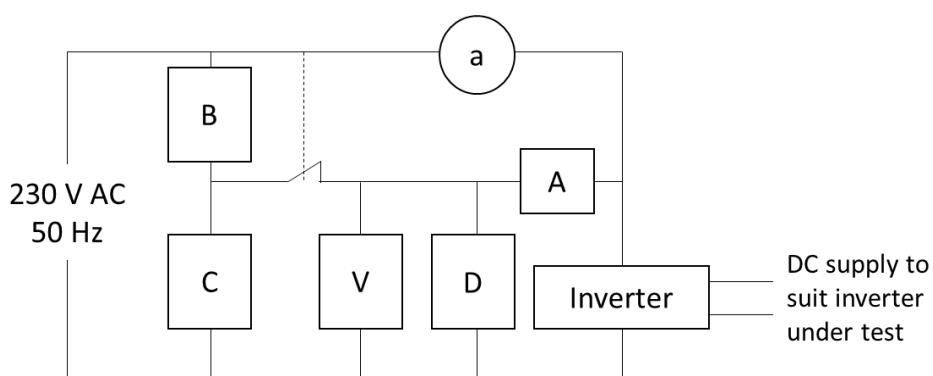

#### Test procedure

In Figure A1.5 'A' and 'V' are ammeters and voltmeters used to record the test data required. Component 'D' is a resistive load plus resonant circuit as required for the loss of mains test as specified in BS EN 62116 set up to absorb 100% **Registered Capacity** of the **Micro-generator**. Component 'a' is an ammeter used to confirm that all the output from the **Inverter** is being absorbed by component D. Components 'B' and 'C' are set up to provide a voltage of between 10% and 40% of nominal when component 'C' carries the **Registered Capacity** of the **Micro-generator** in Amps.

Component 'C' should be short term rated to carry the load which would appear through it should it be energised at 253 V for at least 1 s. Component 'B' is to have an impedance of between 10 and 20  $\Omega$  per phase. If components 'B' and 'C' are short time rated then an additional switch in series with 'B' and 'C' can be inserted and arranged to be closed shortly before the main change over switch shown on the drawing and opened at the end of the test period. Components 'B' and 'C' are to have an X to R ratio of 2.5 to 1.

The test is carried out by setting up the **Micro-generator** and load 'D' to produce and then absorb the **Registered Capacity** of the **Inverter**. When zero export is shown by ammeter 'a' then the changeover switch shown is operated connecting the **Inverter** to the reduced voltage connection created by components 'B' and 'C' and disconnecting it from the normal

connection. The make contact is an early make and the break contact a late break so that the **Micro-generator** is not disconnected from a mains connection for any significant time.

The values of voltage and current should be recorded for a period of up to 1 s when the changeover switch should be returned to the normal position. The voltage and current at relevant times shall be recorded in the **Type Test Verification Report** (Appendix 3 Form C) including the time taken for the **Micro-generator** to trip. (It is expected that the **Micro-generator** will trip on either loss of mains or under voltage in less than 1 s).

#### **A 1.3.6 Self-Monitoring - Solid State Disconnection**

Some **Micro-generators** include solid state switching devices to disconnect from the **DNO's Distribution Network**. In this case paragraph 10.1.9 requires the control equipment to monitor the output stage of the **Micro-generator** to ensure that in the event of a protection initiated trip the output voltage is either disconnected completely or reduced to a value below 50 V AC. This shall be verified either by self-certification by the **Manufacturer**, or additional material shall be presented to the tester sufficient to allow an assessment to be made.

## A.2 Annex A2 Requirements for Type Testing of Synchronous and non-Inverter Micro-generators

### A.2.1 General

This Annex describes a methodology for obtaining type certification or type verification for the interface equipment between a directly coupled **Micro-generator** and the **DNO's Distribution Network**. Interface functions can be provided either as an integrated part of the **Micro-generator** or by incorporating a protection relay but for a **Fully Type Tested Micro-generator** the completed **Micro-generator's Interface Protection** shall not rely on interconnection using cables which could be terminated incorrectly on site ie the interconnections shall be made by non-reversible plug and socket which the **Manufacturer** has made and tested prior to delivery to site.

The **Interface Protection** of synchronous **Micro-generators** shall satisfy the requirements of all of the following standards. Where these standards have more than one part, the requirements of all such parts shall be satisfied, so far as they are applicable.

- BS EN 61000 (Electromagnetic Standards)
- BS EN 60255 (Electrical Relays)
- BS EN 61810 (Electrical Elementary Relays)
- BS EN 60947 (Low Voltage Switchgear and Control gear)
- BS EN 61869 (Instrument Transformers: Additional requirements for current transformers)

Currently there are no harmonised functional standards that apply to the **Micro-generator Interface Protection**, therefore in order to achieve **Fully Type Tested** status the **Micro-generator** and any separate **Interface Protection** unit will require their functionality to be **Fully Type Tested** as described in this Annex, and recorded in format similar to that shown in the **Type Test Verification Report**, Appendix 3 Form C.

Where the **Interface Protection** is physically integrated within the overall **Micro-generator** control system, the functionality of the **Interface Protection** unit should not be compromised by any failure of other elements of the control system (fail safe).

This Annex applies to **Micro-generators**:

- with or without **energy storage systems** connected on the alternator side of the **Micro-generator**; and
- with or without load management devices.

Wherever possible the type testing of a **Micro-generator** utilising a particular type of prime mover should be proved under normal conditions of operation for that prime mover (unless otherwise noted).

This Annex can also be used for asynchronous **Micro-generators** that are not connected to the **Distribution Network** via an **Inverter** as appropriate.

This Annex also applies to any synchronous **Micro-generators** that are powered by stored energy (eg compressed air), but the requirement to demonstrate the **LFSM-O** will not be required.



## A.2.2 Type Verification Functional Testing of the Interface Protection

Type testing is the responsibility of the **Manufacturer**.

The type testing can be done by the **Manufacturer** of an individual component, by an external test house or by the supplier of the complete system, or any combination of them as appropriate.

The type testing will verify that the operation of the **Interface Protection** shall result:

- a) in the safe disconnection of the **Micro-generator** from the **DNO's Distribution Network** in the event that the protection settings specified in Table 2 are exceeded; and
- b) in the **Micro-generator** remaining connected to the **DNO's Distribution Network** while **Distribution Network** conditions are:
  - 1) within the envelope specified by the settings plus and minus the tolerances specified for equipment operation in Table 2; and
  - 2) within the time delay settings specified in Table 2.

### A.2.2.1 Disconnection times

The minimum trip time delay settings, for over / under voltage, over / under frequency and loss of mains tests below, are presented in Table 2.

For over / under voltage, over / under frequency and loss of mains tests, reconnection shall be checked as detailed below.

In some systems it may be safer and more convenient to test the trip delay time and the disconnection time separately. This will allow the trip delay time to be measured in a test environment (in a similar way as for a protection relay). The disconnection time can be measured in the **Micro-generator** normal operation, allowing accurate measurement with correct inertia and prime mover characteristics. This is permitted providing the total disconnection time does not exceed the value specified in Table 2. When measuring the disconnection time where the **Interface Protection** is included in the **Micro-generator**, 5 s disconnections should be initiated, and the average time recorded.

### A.2.2.2 Over / Under Voltage

The **Interface Protection** shall be tested by operating the **Micro-generator** in parallel with a variable AC test supply, as an example see Figure A2.1. Correct protection and ride-through operation shall be confirmed. The set points for over and under voltage at which the **Interface Protection** disconnects from the supply will be established by varying the AC supply voltage. The disconnect sequence should be initiated when the network conditions of Table 2 are met, otherwise normal operation should continue.

To establish the certified trip voltage, the test voltage should be applied in steps of  $\pm 0.5\%$  of setting for a duration that is longer than the trip time delay, for example 1 s in the case of a delay setting of 0.5 s. It will be necessary to carry out five tests for each trip setting. The test voltage at which this trip occurs is to be recorded as the certified trip voltage.

To establish the certified trip time, the test voltage should be applied starting from  $\pm 1.8\%$  below the certified trip voltage in a step of at least  $\pm 0.5\%$  of setting for a duration that is longer

than the trip time delay, for example 1 s in the case of a delay setting of 0.5 s. Where the **Interface Protection** functionality is implemented in the **Micro-generator**, it will be necessary to carry out five tests for each trip setting. The longest trip time is to be recorded as the certified trip time.

For example, to test overvoltage setting stage 1 which is required to be set at nominally 262.2 V the circuit can be set up as shown below and the voltage adjusted to 254.2 V. In integrated designs where there is no separate way of establishing that the **Micro-generator** is disconnected, the **Micro-generator** should be powered up to export a measurable amount of energy so that it can be confirmed that the **Micro-generator** has ceased to output energy. The variable voltage supply is then increased in steps of no more than 0.5% of nominal voltage (1.15 V) maintaining the voltage for at least 1.5 s (trip time plus 0.5 s) at each voltage level. At each voltage level confirmation that the **Micro-generator** has not tripped after the time delay is required to be taken. At the voltage level at which a trip occurs then this should be recorded as the provisional trip voltage. Additional tests just below and if necessary just above the provisional trip voltage will allow the actual trip voltage to be established on a repeatable basis. This value should be recorded. For the sake of this example the actual trip level is assumed to have been established as being 261 V. The variable voltage supply should be set to 257 V, the **Micro-generator** set to produce a measurable output (if necessary) and then the voltage raised to 265 V in a single step. The time from the step change to the disconnection of the **Micro-generator**, the output of the **Micro-generator** falling to zero, should be recorded as the trip time.

To confirm that the protection does not trip before the required time, the test voltage should be applied at each setting  $\pm 4$  V and for the relevant times shown in the **Type Test Verification Report**, Appendix 3 Form C.

Test results should be recorded on the Test Sheet shown in the **Type Test Verification Report**, Appendix 3 Form C.

**Figure A2.1. Micro-generator test set up – over / under Voltage**

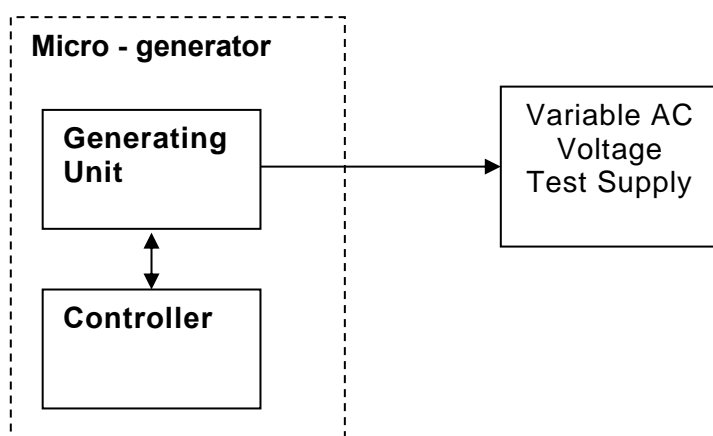

### **A.2.2.3 Over / Under Frequency**

The **Interface Protection** shall be tested by operating the **Micro-generator** in parallel with a low impedance, variable frequency test supply system, as an example see Figure A2.2. Correct protection and ride-through operation should be confirmed during the test. The set

points for over and under frequency at which the **Interface Protection** disconnects from the supply will be established by varying the test supply frequency.

To establish a trip frequency, the test frequency should be applied in a slow ramp rate of less than  $0.1 \text{ Hz s}^{-1}$ , or if this is not possible in steps of 0.05 Hz for a duration that is longer than the trip time delay, for example 1 s in the case of a delay setting of 0.5 s. The test frequency at which this trip occurred is to be recorded. Additional tests just above and below the trip frequency should be undertaken to show that the test is repeatable and the figure at which a repeatable trip occurs should be recorded on the **Type Test Verification Report** Appendix 3 Form C.

To establish the trip time, the test frequency should be applied starting from 0.3 Hz below or above the recorded trip frequency and should be changed to 0.3 Hz above or below the recorded trip frequency in a single step. The time taken from the step change to the **Micro-generator** tripping is to be recorded on the **Type Test Verification Report** Appendix 3 Form C. It should be noted that with some loss of mains detection techniques this test may result in a faster trip due to operation of the loss of mains protection and if possible the loss of mains protection should be turned off in order to carry out this test. Otherwise a much smaller step change should be used to initiate the trip and establish a trip time, which may require the test to be repeated several times to establish that the time delay is correct.

To confirm that the protection does not trip before the required time the test frequency should be applied at each setting  $\pm 0.2 \text{ Hz}$  and for the relevant times shown in the table in the **Type Test Verification Report**, Appendix 3 Form C.

**Figure A2.2 test set up – over / under Frequency**

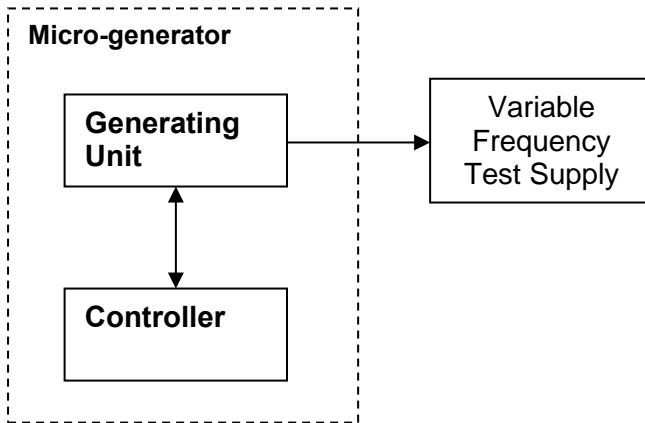

**A.2.2.4 Loss of Mains Protection**

The test described in this Annex should be completed at 10%, 55%, and 100% of the **Registered Capacity**. In both cases a subset of results should be recorded as indicated in the Protection – Loss of Mains test section of the **Type Test Verification Report**, Appendix 3 Form C. Note that if the suggested loading points are below the **Micro-generator's** minimum stable operating level the test should be completed at 100%, and at least one loading level below 100%, of the **Registered Capacity**. It is recommended that a power level is chosen that is 5% of the difference between the **Registered Capacity** and the minimum stable operating level above the minimum stable operating level:

$$\text{Power level} = \text{Minimum stable operating level} + (\text{Registered Capacity} - \text{minimum stable operating level}) \times 0.05$$

operating level) x 5%

The resonant test circuit specified in this test has been designed to model the interaction of the directly coupled **Micro-generator** under test with the local load including multiple directly coupled connected **Micro-generators** in parallel.

The directly coupled **Micro-generators** output shall be connected to a network combining a resonant circuit with a Q factor of  $>0.5$  and a variable load. The value of the load is to match the directly coupled **Micro-generator** output. To facilitate the test for LoM there shall be a switch placed between the test load/directly coupled **Micro-generator** combination and the **DNO's Distribution Network**, as shown in Figure A2.3.

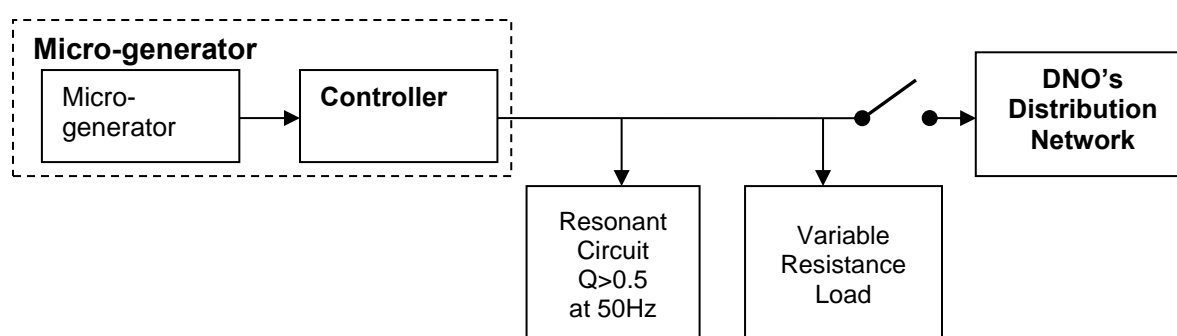

**Figure A2.3 test set up – Loss of Mains**

The directly coupled **Micro-generator** is to be tested at three levels of the directly coupled **Micro-generator's** output power: 10%, 55% and 100%. For each test the load match is to be within  $\pm 5\%$ . Each test is to be repeated five times.

Load match conditions are defined as being when the current from the directly coupled **Micro-generator** meets the requirements of the test load ie there is no export or import of supply frequency current to or from the **DNO's Distribution Network**.

The tests will record the directly coupled **Micro-generator's** output voltage and frequency from at least 2 cycles before the switch is opened until the protection system operates and disconnects itself from the **DNO's Distribution Network**, or for five seconds whichever is the lower duration.

The time from the switch opening until the protection disconnection occurs is to be measured and must comply with the requirements in Table 2.

#### **A.2.2.5 Reconnection**

Further tests will confirm that once the AC supply voltage and frequency have returned to be within the stage 1 settings specified in Table 2 following an automatic protection trip operation there is a minimum time delay of 20 s before the **Micro-generator** output is restored (ie before the **Micro-generator** automatically reconnects to the **Distribution Network**).

#### **A.2.2.6 Frequency Drift and Step Change Stability test**

The tests will be carried out using the same circuit as specified in A.2.2.3 above and following confirmation that the **Micro-generator** has passed the under and over frequency trip tests and the under and over frequency stability tests.

Four tests are required to be carried out with all protection functions enabled including loss of mains. For each stability test the **Micro-generator** should not trip during the test.

For the step change test the **Micro-generator** should be operated with a measurable output at the start frequency and then a vector shift should be applied by extending or reducing the time of a single cycle with subsequent cycles returning to the start frequency. The start frequency should then be maintained for a period of at least 10 s to complete the test. The **Micro-generator** should not trip during this test.

For frequency drift tests the **Micro-generator** should be operated with a measurable output at the start frequency and then the frequency changed in a ramp function at  $0.95 \text{ Hz s}^{-1}$  to the end frequency. On reaching the end frequency it should be maintained for a period of at least 10 s. The **Micro-generator** should not trip during this test.

#### **A.2.2.7 Active Power feed-in at under-frequency**

The tests detailed in A.1.2.7 shall be undertaken to verify the **Active Power** feed-in at under-frequency.

#### **A.2.2.8 Micro-generators which include Electricity Storage**

This paragraph provides a method for demonstrating compliance with the optional performance characteristic as discussed in the foreword. The **Manufacturer** shall demonstrate how the **Micro-generator Active Power** when acting as a load (ie replenishing its energy store) responds to changes in system frequency. In general four tests are proposed, one set of two at rated import capacity, and one set of two at 40% of rated import capacity.

In both cases the test is to reduce frequency from 50 Hz at  $2 \text{ Hz s}^{-1}$ . In the first case the lower frequency reached will be 49.0 Hz and the second case the lower frequency will be 48.8 Hz.

In all cases the response shall meet the requirements of 9.4.3.

#### **A.2.2.9 Power response to over-frequency**

The tests detailed in A.1.2.9 shall be undertaken to verify the power reduction to over-frequency using a specific standard frequency threshold of 50.4 Hz and a **Droop** of 10%.

## POWER QUALITY

### A.2.3.1 Harmonics

The tests should be carried out as specified in BS EN 61000-3-2 and can be undertaken with a fixed source of energy at two power levels firstly between 45 and 55% and at 100% of **Registered Capacity**. Note that if the suggested power levels are below the **Micro-generator's** minimum stable operating level the test should be carried out at 100%, and at least one stable loading level below 100%, of **Registered Capacity**. It is recommended that a power level is chosen that is 5% of the difference between the **Registered Capacity** and the minimum stable operating level above the minimum stable operating level:

$$\text{Power level} = \text{Minimum stable operating level} + (\text{Registered Capacity} - \text{minimum stable operating level}) \times 5\%$$

The test shall be carried out with a minimum of 2 kW of rated **Micro-generators**. Where an individual **Micro-generator** is smaller than 2 kW it should be tested as a group. However, where a **Micro-generator** is designed to be installed singly in an installation then this can be tested alone, for example a domestic CHP unit. The maximum group size for the test is 3.68 kW.

### A.2.3.2 Power Factor

The test set up shall be such that the directly coupled **Micro-generator** supplies full load to the **DNO's Distribution Network** via the power factor (pf) meter and the variac as shown below in Figure A2.4. The directly coupled **Micro-generator** power factor should be within the limits given in paragraph 9.6 for the three test voltages 230 V -6%, 230 V and 230 V +10%. The voltage shall be maintained within  $\pm 1.5\%$  of the stated level during the test.

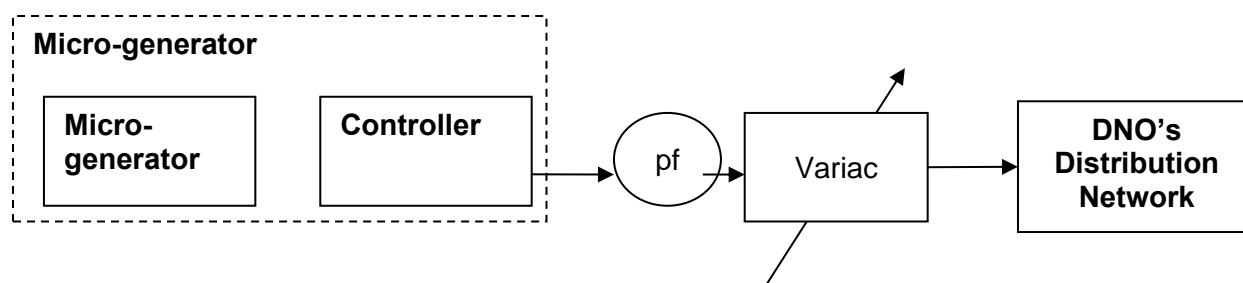

NOTE 1. For reasons of clarity the points of isolation are not shown

NOTE 2: It is permissible to use a voltage regulator or tapped transformer to perform this test rather than a variac as shown

**Figure A2.4 test set up – Power Factor**

### A.2.3.3 Voltage Flicker

The test shall be carried out with a minimum of 2 kW of rated **Micro-generators**. Where an individual **Micro-generator** is smaller than 2 kW it should be tested as a group. However, where a **Micro-generator** is designed to be installed singly in an installation then this can be tested alone, for example a domestic CHP unit. The maximum group size for the test is 3.68 kW.

The **Micro-generator** or group shall meet the required  $d_{max}$ ,  $d_c$ ,  $d_{(t)}$ ,  $P_{st}$ ,  $P_{lt}$  requirements of BS EN 61000-3-3 with a scaling factor applied as follows for each voltage change component.

$$d_{max}, d_c, d_{(t)}, P_{st}, P_{lt} \times \text{rating of Micro-generator being tested (kW) per phase} / 3.68$$

For voltage change and flicker measurements the following simplified formula is to be used to convert the measured values to the normalised values where the power factor of the **Micro-generator** output is 0.98 or above. Where it is less than 0.98 then compliance with the full requirements of BS EN 61000-3-3 is required.

Normalised value = Measured value  $\times$  reference source resistance/measured source resistance at test point.

And for units which are tested as a group.

Normalised value = Measured value  $\times$  reference source resistance/measured source resistance at test point  $\times$  3.68/rating per phase.

Single phase units reference source resistance is 0.4  $\Omega$ .

Two phase units in a three phase system reference source resistance is 0.4  $\Omega$ .

Two phase units in a split phase system reference source resistance is 0.24  $\Omega$ .

Three phase units reference source resistance is 0.24  $\Omega$ .

The stopping test should be a trip from full load output.

The dates and location of the tests need to be noted in the **Type Test Verification Report**, Appendix 3 Form C.

**Hydro Micro-generators** with manually fixed output or where the output is fixed by controlling the water flow through the turbine to a steady rate, need to conform to the maximum voltage change requirements of BS EN 61000-3-2 but do not need to be tested for  $P_{st}$  or  $P_{lt}$ .

#### **A.2.3.4 Short Circuit Current Contribution for Directly Coupled technology**

**DNOs** need to understand the contribution a **Micro-generator** makes to system fault levels in order to determine that they can continue to safely operate without exceeding design fault levels for switchgear and other circuit components.

For rotating machines BS EN 60034-4:1995 Methods for determining synchronous machine quantities from tests shall be used to establish the parameters required to be recorded in **Type Test Verification Report** Appendix 3 Form C under the section fault level contribution.

For rotating machines and linear piston machines the test shall produce a 0 – 2 s plot of the short circuit current as seen at the **Micro-generator** terminals.

The short circuit current contribution shall be measured upon application of a short circuit on the **Micro-generator** terminals (all phases / phase to neutral) with the **Micro-generator(s)** operating at rated output steady state conditions.

Current measurements shall be taken from application of fault until the time the fault has been disconnected, following operation of the **Micro-generator** protection. A current decay plot

shall be produced for each phase from inception of the fault until the **Micro-generator** has been disconnected – trip time. The plot shall show the highest value of peak short circuit current, eg for a **Micro-generator** supplying a purely inductive load the highest value of peak short circuit current will result when the fault is applied at a voltage zero. Where practicable the tests will need to determine values for all of the relevant parameters listed in Table A.1.

**Table A.1 Micro-generator Short Circuit Parameters**

<b>Parameter</b>	<b>Symbol</b>	<b>Method of Determination</b>
Peak short-circuit current	$i_p$	Direct measurement
Initial value of aperiodic component	A	Direct measurement
Initial symmetrical short-circuit current	$I_k''$	Interpolation of plot
Decaying (aperiodic) component of short-circuit current	$i_{dc}$	Interpolation of plot & calculation
Reactance / Resistance ratio of source	$X/R$	Calculation